



Land-Form PROFILE[®]

User guide and technical specification

Land-Form PROFILE

User guide

Contents

Section	Page no
Preface	3
Contact details	3
Use of the product.....	3
Purpose and disclaimer	3
Copyright in this guide	4
Data copyright and other intellectual property rights	4
Trademarks	4
Back-up provision of the product	4
Using this guide.....	4
Chapter 1 Introduction	5
Using this guide.....	5
Land-Form – an introduction.....	5
Land-Form PROFILE features	5
Land-Form PROFILE benefits	6
What you need to use Land-Form PROFILE.....	6
Hardware	6
Software.....	6
Land-Form PROFILE supply options.....	6
Transfer format(s)	6
Media	6
Land-Form PROFILE supply unit.....	6
Update/update options.....	7
National Transfer Format (NTF) release.....	7
Chapter 2 Overview of Land-Form PROFILE	8
Data overview	8
Basic principles	8
Land-Form PROFILE application overview	8
Typical user scenarios	8
Integration within GIS.....	8
Chapter 3 Land-Form PROFILE explained	9
Contours.....	9
Tide lines.....	9
Air and spot heights	9
Land-Form PROFILE data structure	10
Geometric data.....	10
Horizontal.....	10
Vertical.....	10
Attribute data.....	10
Feature position	10
Feature codes	10
Feature serial number (FSN)	11
Edgematch.....	11
Land-Form PROFILE data source	11
Survey method and accuracy	11
Digital capture methods	12
Ordnance Survey datum	12
DTMs.....	13
Introduction	13
Accuracy	13
Edgematch.....	13
Data overview – DTMs.....	14
Chapter 4 Tile numbering and the National Grid.....	15
Annexe A Product and service performance report form	16

Preface

This user guide (hereafter referred to as the guide) is designed to provide an overview of Land-Form PROFILE (hereafter referred to as the product) and it gives guidelines and advice on how a customer might derive the maximum benefit from the product. It assumes a general knowledge of geographic information. If you find an error or omission in this guide, or otherwise wish to make a comment or suggestion as to how we can improve the guide, please contact us at the address shown below under contact details or complete the product and service performance report form at [annexe A](#) and return it to us.

Contact details

Our Customer Service Centre will be pleased to deal with your enquiries:

Customer Service Centre
Ordnance Survey
Adanac Drive
SOUTHAMPTON
United Kingdom
SO16 0AS

General enquiries (calls charged at local rate): +44 (0)8456 05 05 05

Dedicated Welsh Language HelpLine: 08456 05 05 04

Textphone (deaf and hard of hearing users only please): +44 (0)23 8005 6146

customerservices@ordnancesurvey.co.uk

www.ordnancesurvey.co.uk

This document has been screened in accordance with the requirements set out in Ordnance Survey's Equality Scheme. If you have difficulty reading this information in its current format and would like to find out how to access it in a different format (Braille, large print, computer disk or in another language), please contact us on: +44 (0)8456 05 05 05.

Use of the product

The terms and conditions upon which the product, including this guide, is made available to you and your organisation are contained in the customer contract made between you and Ordnance Survey. If there is an inconsistency between the terms of your customer contract and this guide, then the terms of your customer contract prevail. If you or your organisation has not signed a valid current customer contract then you are not entitled to use the product.

Purpose and disclaimer

This guide is provided for guidance only and does not constitute any warranty, representation, undertaking, commitment or obligation (express or implied) about the product or its suitability for any particular or intended purpose. Any warranties, representations, undertakings, commitments and obligations given by Ordnance Survey about the product and/or its suitability for any particular or intended purpose are set out in your customer contract. It is your responsibility to ensure that this product is suitable for your intended purpose.

Ordnance Survey does not accept any liability (whether for breach of contract, negligence or otherwise) for any loss or liability you or any third party may suffer in relying on this guide and any guidance, suggestion, advice or explanation provided in it. Any liability that Ordnance Survey has to you in relation to the product, its supply, use, accuracy, data supplied, functionality or any other liability arising out of or in connection with the product is limited as set out in your customer contract.

We may change the information in this guide at any time without notice.

We do not accept responsibility for the content of any third party websites referenced or accessed in or through this guide, any contractual documentation, and/or the Ordnance Survey website.

Copyright in this guide

This guide (including for the avoidance of doubt any mapping images reproduced herein), is © Crown copyright 2012. All rights reserved.

Any part of this guide may be copied for use internally in your organisation or business so that you can use the product for the purpose for which it is licensed to your organisation or business (but not otherwise).

No part of this guide may be reproduced or transmitted in any form or by any means (including electronically) for commercial exploitation without the prior written consent of Ordnance Survey.

No part of this guide may be copied or incorporated in products, services or publications that you generate for onward sale, or as free promotional or support materials, without the prior written consent of Ordnance Survey.

Data copyright and other intellectual property rights

The Crown (or, where applicable, Ordnance Survey's suppliers) owns the intellectual property rights in Ordnance Survey digital map data.

Full details of the terms and conditions under which Ordnance Survey digital map data may be processed and/or manipulated or copied by a customer – whether or not for use on PCs or workstations or for making hard copies – are available from the Customer Service Centre, please see [contact details](#). You should check the terms and conditions with us before using the data. It is also the responsibility of the holder of the digital map data to ensure that any plotted or printed output contains the required copyright and database acknowledgements in a conspicuous position.

Trademarks

Ordnance Survey, the OS Symbol, Land-Form PROFILE, ADDRESS-POINT, Land-Form PANORAMA, Land-Line and OSGB36 are registered trademarks of Ordnance Survey, the national mapping agency of Great Britain.

Adobe and Acrobat Reader are registered trademarks of Adobe Systems Incorporated.

AutoCAD and Autodesk are registered trademarks and DXF is a trade mark of Autodesk Inc.

ESRI is a registered trademark of Environmental Systems Research Institute, Inc.

MapInfo is a registered trademark of MapInfo Corporation.

Back-up provision of the product

You are advised to copy the supplied data to a back-up medium.

Using this guide

The documentation is supplied in portable document format (PDF) only. Free Adobe® Acrobat Reader® software, which displays the guide, incorporates search and zoom facilities and allows you to navigate within. Hyperlinks are used to navigate between associated parts of the guide and to relevant Internet resources by clicking on the blue hyperlinks and the table of contents.

If you are unfamiliar with any words or terms used and require clarification please refer to the [glossary](#) at the end of the document.

Chapter 1 Introduction

Using this guide

This user guide is an introduction to Land-Form PROFILE which offers guidance and advice on how to deliver the maximum value from the product. The technical specification provides specific details of the structure, content and formats of Land-Form PROFILE for customers using the data in a geographical information system (GIS) or other systems. The technical specification should be used in conjunction with the user guide.

This chapter and [chapter 2](#) provide an introduction to Land-Form PROFILE and illustrate potential applications. [Chapter 3](#) contains more detailed information about the data. These chapters are designed to enable users to make effective use of Land-Form PROFILE and contain all the information you will need. Please refer to the [glossary](#) at annex A of the Technical Specification if you are unfamiliar with any of the terms used.

All aspects of Land-Form PROFILE discussed in this user guide relate to Land-Form PROFILE in both BS 7567 (NTF v2.0) and DXF™ (AutoCAD® release 12) formats. If the two format versions differ in their treatment of a particular aspect, the specific differences will be stated. Icons, as shown below, will be used to denote these differences.



For convenience BS 7567 (NTF v2.0 Level 2) is referred to as NTF and BS 7567 (NTF v2.0 Level 5) is referred to as NTF Level 5 in this user guide.



Data Exchange Format is referred to as DXF in this user guide. DXF AutoCAD release 12 compatible data complies with *Layer Naming Convention for CAD in the Construction Industry Version 2*, which is based upon the guidelines laid down in BS 1192: Part 5.

Land-Form – an introduction

Land-Form is the generic name given to all Ordnance Survey digital height products. These consist of:

- Land-Form PROFILE, which is dealt with in this user guide.
- Land-Form PANORAMA®, which is dealt with in the *Land-Form PANORAMA user guide*.
- Land-Form PROFILE® Plus, which is dealt with in the *Land-Form PROFILE Plus technical specification*.

Land-Form PROFILE features

Ordnance Survey's Land-Form PROFILE data is a dataset representing the physical shape of the real world.

The data is available to customers as:

- **Land-Form PROFILE contour tiles**, including: contours, air heights, spot heights, and high and low water marks.
- Contour data and selected air heights are captured from Ordnance Survey's 1:10 000 scale mapping; this is supplemented by spot heights, and high and low water marks from Ordnance Survey 1:1250, 1:2500 and 1:10 000 scale digital data.
- **Land-Form PROFILE digital terrain model (DTM) tiles**, a 10 metre grid of heightened points derived from the contour product.

All tile sizes are 5 km by 5 km.

Land-Form PROFILE benefits

- National coverage.
- Five metre contour interval and 10 metre in some mountain and moorland areas.
- Mean high and low water mark in England and Wales and mean high and low water springs in Scotland.
- Indexed contours every 25 metres, and 50 metres in mountainous areas.
- Contours and DTMs fully edgematched.
- Coded features which give each feature a specific category.
- Choice of supply formats – NTF or DXF.
- Air and spot heights.

What you need to use Land-Form PROFILE

Hardware

Hardware requirements will vary depending on the data volumes users wish to access.

Average tile sizes are as follows:

- vector contour files in NTF Level 2 1.2 Mb
- vector contour files in DXF 4.0 Mb
- DTMs in NTF Level 5 1.5 Mb
- DTMs in DXF 19.5 Mb

Users wishing to access large amounts of data will require large storage and processing capacities running on a workstation platform, while modern personal computer (PC) based applications will be sufficient for users only needing to use small amounts. Your system supplier will be able to advise on your requirements.

Software

Land-Form PROFILE is inert data and does not include software for data viewing or manipulation. To fully exploit its potential it is necessary to have appropriate application software. There are many proprietary systems available and we publish a list of GIS, computer-aided design (CAD) and digital mapping licensed system suppliers who have confirmed that their software can import Land-Form PROFILE in either NTF or DXF.

Land-Form PROFILE supply options

Transfer format(s)

Land-Form PROFILE contours are supplied in:

- BS 7567 (NTF v2.0) Level 2 [See chapter 1, technical specification](#)
- DXF AutoCAD release 12 compatible [See chapter 3, technical specification](#)

Land-Form PROFILE DTMs are available in:

- BS 7567 (NTF v2.0) Level 5 [See chapter 1, technical specification](#)
- DXF AutoCAD release 12 compatible [See chapter 3, technical specification](#)

Media

Land-Form PROFILE is supplied in NTF on the standard Ordnance Survey media range, whilst DXF is available on CD-ROM only.

Land-Form PROFILE supply unit

Land-Form PROFILE is supplied in tiles. Each covers an area of 5 km by 5 km. There are 10 577 tiles in the series.

Update/update options

Updated Land-Form PROFILE contour and DTM tiles will be supplied, when available, as part of three-year contracts.

National Transfer Format (NTF) release

The current release is NTF v2.0 and will be supplied until further notice. [See chapter 1, technical specification](#)

Chapter 2 Overview of Land-Form PROFILE

Data overview

Basic principles

- **Land-Form PROFILE contour data** is defined as geometrically structured vector point and line data. This is to say, that a contour consists of a series of points which are linked by a continuous line. This also applies to the mean high water (MHW) and mean low water (MLW) marks, but the MLW will be omitted where coincident with the MHW. Spot heights consist of a single point in the data.
- **Land-Form PROFILE DTMs** consist of a gridded array of heighted points at 10 m intervals. In NTF the data consists of a list of height values whose position within the tile is implied by its position within the data file. In DXF each point in the data has a set of National Grid coordinates as well as a height value.

Land-Form PROFILE application overview

Typical user scenarios

- Land-Form PROFILE provides an ideal base using an appropriate geographical information system (GIS), over which to *drape* other data in order to facilitate many height critical applications.

Integration within GIS

Land-Form PROFILE can be used in a variety of applications, in many cases in conjunction with other Ordnance Survey digital products, for analytical, modelling, planning and visual purposes to enable:

- Terrain modelling;
- Wind farm location;
- Archaeological survey;
- Water pressure and sewage network analysis;
- River catchment and pollution analysis;
- Flood risk assessment;
- Environmental impact analysis;
- Scatter modelling;
- Civil engineering project developments;
- Visual impact and view-shed analysis;
- Property and asset management;
- Utilities asset management and development;
- Radio wave propagation;
- Flight simulation;
- Forestry planning;
- Geological analysis;
- line of sight planning; or
- fly-through sequences.

Chapter 3 Land-Form PROFILE explained

Contours

There are two types of contour in Land-Form PROFILE – standard contours and index contours.

Contours are shown at a vertical interval (VI) of 5 m, except in mountain and moorland areas where the VI is 10 m.

In areas where the VI is 5 m, the index contours are at multiples of 25 m.

In areas where the VI is 10 m, the index contours are at multiples of 50 m.

All contours consist of one continuous feature across a tile except that:

- They do not contain more than 2 500 data points.
- In areas of steep slope some contours will be omitted. This is where some contours were omitted from the graphic product for cartographic purposes.
- Where coincident with man-made features, contours may be broken. In general, contours were not shown on 1:10 000 scale mapping where they coincided with published man-made slopes.
- Contours are not shown in active quarries, gravel pits, spoil heaps or open cast mines.

Tide lines

Ordnance Survey shows high and low water marks of a mean tide – an average tide halfway between spring and neap tides – in England and Wales, and of average spring tides in Scotland. This line will cross tidal rivers at the point to which mean tides, or in Scotland spring tides, flow at high water; this is known as the normal tidal limit (NTL).

Air and spot heights

Spot heights are heighted points captured by ground methods, and are normally positioned along the centre of roads and *air heights* are heighted points captured by photogrammetric methods at the same time as the contours. They are normally shown in the following positions:

Hill tops

At the highest point.

Saddles

On important features.

Valley junctions

Generally at the junction of main rivers and streams.

River crossings

At natural ground level.

Roads

At marked changes of gradient, or at about 500 m intervals along roads with no marked change of gradient.

Road junctions

In town areas they are confined to main road junctions. Minor road junctions are included in rural areas.

Artificial features

In confined circumstances (for example, ancient earthworks) where the topography is depicted by slope symbols instead of contours, a single central spot height is captured. On extended features, spot heights are captured at intervals of 750 m.

Low-lying areas

In large areas between the lowest contour and mean high water, supplementary spot heights are plotted at a frequency of about 750 m.

Flat areas

In extensive areas devoid of contours, spot heights are positioned on any eminence or significant detail.

Land-Form PROFILE data structure

Land-Form PROFILE contour data comprises point and line features as follows:

Point features

spot heights	three-dimensional
air heights	three-dimensional

Line features

standard contours	three-dimensional (NTF and DXF)
index contours	three-dimensional (NTF and DXF)
MHW or MLW	three-dimensional (NTF and DXF)

Each point or line feature itself consists of two data categories: **geometric data** and **attribute data**. Geometric data defines a feature's position in terms of National Grid coordinates and height, and attribute data, its descriptive characteristics.

Geometric data

Horizontal

The geometry of map features is defined in terms of coordinates. All coordinates used in Land-Form PROFILE are based on the National Grid (NG) coordinate referencing system, and are quoted to a resolution of 1 cm on the ground. However, the data can be no more accurate than its source, that is 1:10 000 scale mapping for air heights and contours, and 1:1250, 1:2500 or 1:10 000 scale mapping for spot heights and tide lines.

Vertical

Height information is given relative to Ordnance Survey datum ([see Ordnance Survey datum](#)). Height values are given to a resolution of 1 cm but will have an accuracy dependent on the survey method used to fix the height.

The NG as it applies to Land-Form PROFILE is explained in [chapter 4 of the user guide](#).

Attribute data

An attribute is the descriptive characteristic of a feature, that is, a non-spatial element. The geometry of the points and lines within the data would be meaningless unless they are assigned some distinguishing property. In Ordnance Survey map data terms, an attribute can be a feature code (in NTF Level 2 these are numeric codes), or a distinctive name or number.

Feature position

The geometry of map features is identified in terms of coordinates. All coordinates used in Land-Form PROFILE are based on the National Grid coordinate referencing system and are quoted to 1 cm (0.01 m) resolution. Despite this, Land-Form PROFILE can be no more accurate than its source, primarily 1:10 000 scale published mapping.

Feature codes

There are three types of feature in the data, with six feature codes (FCs).

		NTF (FC)	DXF (Layer)
contours	index contours	1361	G8021361
	standard contours	0075	G8020075
heights	air heights	1372	G8021372
	spot heights	0027	G8020027
tide lines	high water level	0071	G8020071
	low water level	0072	G8020072

Feature serial number (FSN)



Each feature is given an FSN which is unique within a tile. Every attempt is made to maintain the integrity of FSNs.

FSNs are never reallocated, that is once a feature is deleted its FSN is never given to a new feature, therefore there may be gaps in the FSNs.

New features are always given the next highest available FSN.

Edgematch

All contour tiles are edgematched. Where a contour ends by intersecting the tile edge, it is matched with the corresponding contour on the adjoining tile such that both contours:

- end on the same unique coordinate;
- have the same feature code;
- have the same height attribute; and
- have the same direction.

Where areas of 5 m VI contours abut 10 m VI contours, alternate 5 m contours are terminated on the tile edge, therefore edgematching is not complete.

Tide lines may have been surveyed at different times on adjacent sheets and for this reason have been edgematched for planimetric position but not for height.

Land-Form PROFILE data source

Survey method and accuracy

Contours

Ordnance Survey 1:10 000 scale mapping was recontoured as part of a programme, completed in 1987, using photogrammetric techniques. Some small areas, which were not visible on the photography, were surveyed by ground methods.

Contour values are recorded in 5 m vertical intervals and 10 m vertical intervals in some mountainous areas.

Tide lines

These have been surveyed at the basic scale of survey on Ordnance Survey Land-Line data, and may have been captured at 1:1250, 1:2500 or 1:10 000 scale using photogrammetric or ground survey methods.

Where MHW and MLW are coincident, only MHW is shown.

Each point on a feature is assigned a height, to the nearest 0.01 m, derived from Admiralty tide tables. This value is the same across a single 1:10 000 scale tile except where the England and Scotland boundary crosses a tide line. Where this occurs, the tide line is split at the border and the correct national value applied to each section. On edgematch there may be a difference in height between tiles.

MHW heights can vary along the coast from a minimum of 0.09 m to a maximum of 5.62 m above Newlyn Datum.

MLW heights can vary along the coast from a minimum of -4.1 m to a maximum of 2.5 m above Newlyn Datum.

Spot heights

Spot heights were fixed by ground survey methods, mainly spirit levelling, at the time the national bench mark network was established. They are recorded to the nearest 0.1 m.

Some additional spot heights were surveyed using height traversing techniques to supplement air heights in areas of sparse control. They are recorded to a precision of 1.0 m.

Air heights

Air heights were surveyed by photogrammetry at the same time as the contours. They are recorded to the nearest 1.0 m.

Digital capture methods

Air heights and contours are scanned and vectorised from 1:10 000 scale contour negatives used to produce the 1:10 000 scale graphic product.

The digitised contours are such that, when following the direction of digitising, the higher land is to the left and the lower land is to the right. This ensures that labelling routines, polygon infilling algorithms and so on are able to interpret the direction of slope.

Where air heights coincide with spot heights they are omitted.

Tide lines and spot heights have been digitised as part of Ordnance Survey's large scale digitising programme for Land-Line data. This data is extracted from the large scales database and merged into the contour files. The direction of digitising for tide lines is not specified, nor consistent.

Surveyed units of change

The appropriate surveyed units of change are recorded in the [Section Header Record](#) [SECHREC] 07 under HO_UNIT_COUNT, this will be incremented to reflect changes to the ground surface that have been made to the tile and its update date under DATE_LST_CHANG.

A unit of change (addition or amendment) may be any one of the following or their combinations:

tide lines	1 unit per 100 m
spot heights	1 unit per 16 spot heights
contours	1 unit per 100 m or 1 unit per hectare
air heights	1 unit per 4 air heights

Deletions due to the removal or cancellation of any of the above features 0.25 unit

Ordnance Survey datum

Heights are normally measured in relation to Newlyn Datum, with the exception of some offshore islands, where a local datum will have been used. The {Z_DATUM} field in the [Section Header Record](#) (see chapter 2) indicates which datum is used by giving a numerical value from the list below.

List of datum values and the datum to which they refer:

Datum	Value	Notes
Newlyn	0	
Colonsay	1	
Isles of Scilly	2	
Lundy	3	
Orkney (Northern Group)	4	Not used, use 0
Outer Hebrides Group	5	
St Kilda	6	Not used, use 5
Shetland Group	7	
Bardsey	8	Not used, use 0
Canna	9	
Coll	10	
Eigg	11	
Rúm	12	
Tiree	13	
Unspecified	14	

The numerical value given to a tile indicates that part of the data on that tile is directly derived from one of the data listed. If a tile has no data directly derived from one of the listed data, it will be numbered 14 – unspecified.

There may be instances where a tile is numbered because part of the data on the tile is directly derived from one of the listed data, but some isolated islands on that tile may be unspecified.

DTMs

Introduction

As an alternative to contour files, Land-Form PROFILE can be supplied as a digital terrain model (DTM). This takes the form of a 10 m grid of heightened points. DTMs are created from the Land-Form PROFILE contour files.

Accuracy

The process of creating DTMs utilises all the height information contained in the contour file to generate the height of each of the points in the DTM. The results achieved will depend on the density of height data contained in the contour file.

In some flat areas where there is little height information, contours and spot heights may be a great distance apart, this can cause irregularities in the DTM which appear as slight terracing of the terrain.

The height accuracy of any point in the DTM is equal to or better than half the contour interval, that is ± 2.5 m for areas with 5 m VI and ± 5 m for areas with 10 m VI.

Edgematch

To allow the DTM creation software to interpolate accurately around the edges of each tile and avoid edge discrepancies due to lack of edge information, the following operations are carried out:

- Firstly, all edge contour tiles are utilised to create a 1 km buffer of information around each tile (see figure 1 below).
- From this, a 7 km by 7 km DTM is created.
- This 7 km by 7 km DTM is then trimmed to 5 km by 5 km.

This process in effect creates a 2 km-wide buffer of common data between adjacent tiles and will remove most of the edge discrepancies associated with creating DTMs from single contour tiles.

There may however, still be small residual errors along the common edge between tiles; to overcome this, the DTM edges are then *blended* to ensure that all common points on adjacent tiles have the same value.

Each block of tiles supplied to customer order has all internal edges *blended*. External edges will not be *blended*, unless an adjacent DTM already exists. For this reason, adjacent tiles supplied at different times may contain slight differences in height along their common edge.

Figure 1

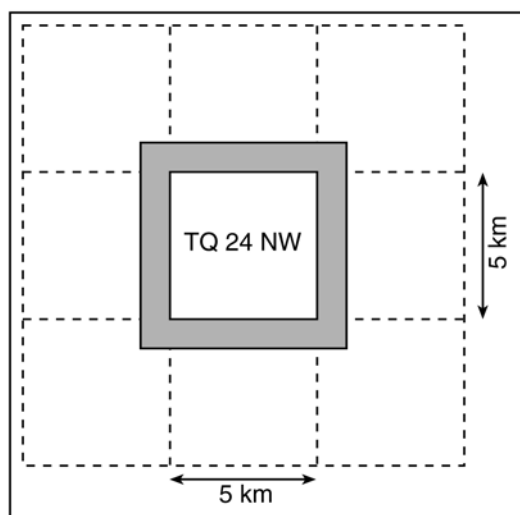

Data overview – DTMs

The DTM tiles in both NTF and DXF consist of a series of heightened points arranged on a 10 m grid comprising 501 by 501 points.



The points themselves do not hold any horizontal coordinate information – their position being implied by the order in which they are held. The format of the grid is included in the map header and follows the following pattern: the first point is positioned on the south-west corner of the tile, with further points at 10 m intervals northwards to the northern edge of the tile; the next point will be on the south edge 10 m east of the origin, again progressing in 10 m intervals to the north edge.



Each of these points have full three-dimensional coordinates.

The first point is positioned on the south-west corner of the tile, with further points at 10 m intervals northwards to the northern edge of the tile, creating a column of 501 points. The next column will start on the southern edge of the tile 10 m east of the origin, again progressing in 10 m intervals to the north edge of the tile.

For both data formats, this pattern is repeated until the final point, which falls on the north-east corner of the tile. Therefore, there are a total of 251 001 points on each tile.

Chapter 4 Tile numbering and the National Grid

The National Grid (NG) provides a unique reference system that can be applied to all Ordnance Survey maps of Great Britain, at all scales.

Great Britain is covered by 100 kilometre grid squares with each square identified by two letters.

Figure 2 – Each NG square of 100 km by 100 km contains 400 (5 km by 5 km) squares. Land-Form PROFILE is supplied to customers in 5 km by 5 km tiles. These are referenced by NG letters followed by the appropriate numbers and figures which obey the 1:10 000 scale sheet numbering convention.

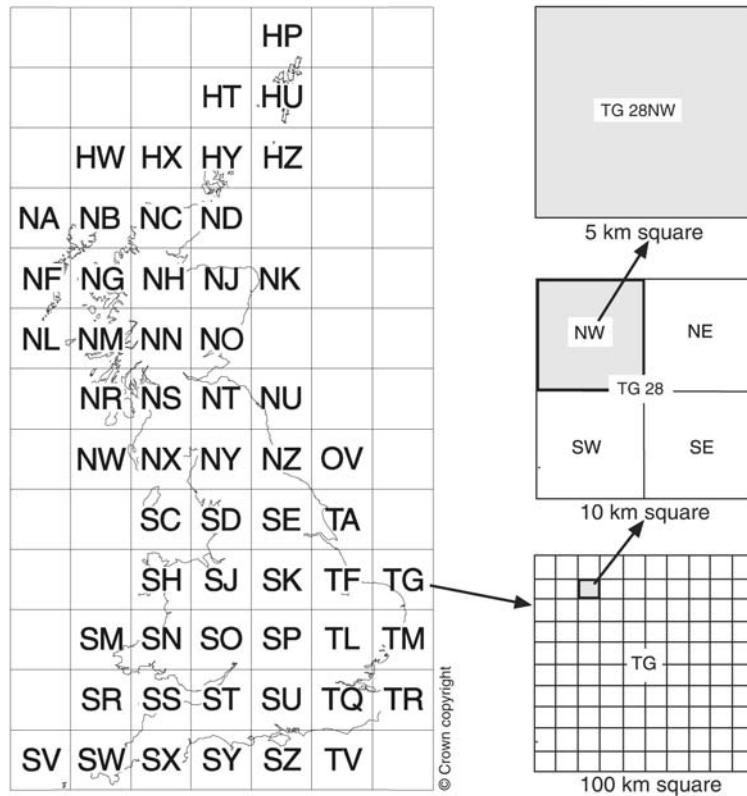

Annexe A Product and service performance report form

Ordnance Survey welcomes feedback from its customers about Land-Form PROFILE.

If you would like to share your thoughts with us, please print a copy of this form and when completed post or fax it to the address below.

Your name:

Organisation:

Address:

.....

.....

Postcode:

Phone:

Fax:

Email:

Quotation or order reference:

Please record your comments or feedback in the space below. We will acknowledge receipt of your form within three (3) working days and provide you with a full reply or a status report within 21 working days.

If you are posting this form, please send it to:

Land-Form PROFILE Product Manager, Ordnance Survey, Adanac Drive, SOUTHAMPTON, SO16 0AS.

If you wish to return it by fax, please dial +44 (0)8450 990494.

Any personal information that you supply with this report form will be used by Ordnance Survey only in the improvement of its products and services. It will not be made available to third parties.

Land-Form PROFILE

Technical specification

Contents

Section	Page no
Introduction	19
Purpose of this specification and disclaimer	19
Copyright in this specification	19
Chapter 1	NTF explained 20
An overview of Land-Form PROFILE in NTF	20
Conventions used in this user guide	20
Data overview	21
File structure	21
Version management	21
Product copyright	21
NTF version	21
General	22
Record size	22
Continuation mark {CONT_MARK} and Continuation Record [CONTREC]	22
Record terminator {EOR}	22
Transfer set	22
Supply of data on formatted media	22
Transfer set structure	22
Volume records	22
Database records	23
Section records	23
Structure of Land-Form PROFILE contours in NTF	24
Section data records for contours	25
Coordinate referencing system for contours	25
Structure of Land-Form PROFILE DTMs in NTF	26
Section data records for DTMs	26
Coordinate reference system for DTMs	27
Chapter 2	Record structures for the transfer of Land-Form PROFILE in NTF 28
NTF record list for Land-Form PROFILE contours	28
Land-Form PROFILE contours	29
Volume Header Record [VOLHDREC] 01 for Land-Form PROFILE contours	29
Database Header Record [DBHREC] 02 for Land-Form PROFILE contours	30
Feature Classification Record [FEATCLASS] 05 for Land-Form PROFILE contours	31
Section Header Record [SECHREC] 07 for Land-Form PROFILE contours	32
Attribute Record [ATTREC] 14 for Land-Form PROFILE contours	34
Point Record [POINTREC] 15 for Land-Form PROFILE contours	34
Two-dimensional Geometry Record [GEOMETRY1] 21 for Land-Form PROFILE contours	35
Three-Dimensional Geometry Record [GEOMETRY2] 22 for Land-Form PROFILE contours	35
Line Record [LINEREC] 23 for Land-Form PROFILE contours	36
Attribute Description Record [ATTDESC] 40 for Land-Form PROFILE contours	36
Volume Terminator Record [VOLTERM] 99 for Land-Form PROFILE contours	37
NTF record list for Land-Form PROFILE DTMs	38
Land-Form PROFILE DTMs in NTF	38
Volume Header Record [VOLHDREC] 01 for Land-Form PROFILE DTMs	38
Database Header Record [DBHREC] 02 for Land-Form PROFILE DTMs	39
Data Description Record [DATADESC] 03 for Land-Form PROFILE DTMs	40
Data Format Record [DATAFMT] 04 for Land-Form PROFILE DTMs	41
Section Header Record [SECHREC] 07 for Land-Form PROFILE DTMs	42
Grid Header Record [GRIDHREC] 50 for Land-Form PROFILE DTMs	44
Grid Data Record [GRIDREC] 51 for Land-Form PROFILE DTMs	45
Volume Terminator Record [VOLTERM] 99 for Land-Form PROFILE DTMs	45
Chapter 3	DXF explained 46

	An overview of Land-Form PROFILE	46
	Structure of Land-Form PROFILE contours	46
	Line features	46
	Structure of Land-Form PROFILE DTMs.....	46
	Land-Form PROFILE DXF layers	46
	Generalised feature record representation	46
	Land-Form PROFILE footnotes	47
	Layers lists	49
	Land-Form PROFILE DTMs in DXF	49
	Land-Form PROFILE Contours in DXF	49
	Overview of DXF file structure for Land-Form PROFILE.....	49
Chapter 4	DXF file structure for Land-Form PROFILE.....	50
	General	50
	Data structure.....	50
	Header section	50
	Tables section.....	52
	Linetype table.....	53
	Layer table	54
	Style table	55
	Blocks section	57
	Entities section.....	59
	End of file group.....	61
Annexe A	Glossary.....	62

v5.4 – 8/20122

Introduction

Purpose of this specification and disclaimer

This is the technical specification (hereafter referred to as the specification) applicable to the Land-Form PROFILE (hereafter referred to as the product) which is referred to in the Framework Direct Licence, Specific Use Framework Partner Licence or your other customer contract for the product.

We may change the information in this specification at any time, giving you the notice period specified in the customer contract made between you and Ordnance Survey.

We do not accept responsibility for the content of any third party websites referenced or accessed in or through this specification, any other contractual documentation, and/or the Ordnance Survey website.

Copyright in this specification

This specification, (including for the avoidance of doubt any mapping images reproduced herein), is © Crown copyright 2012. All rights reserved.

Any part of this specification may be copied for use internally in your organisation or business so that you can use Land-Form PROFILE for the purpose for which it is licensed to your organisation or business (but not otherwise).

No part of this specification may be reproduced or transmitted in any form or by any means (including electronically) for commercial exploitation without the prior written consent of Ordnance Survey.

No part of this specification may be copied or incorporated in products, services or publications that you generate for onward sale, or as free promotional or support materials, without the prior written consent of Ordnance Survey.

Chapter 1 NTF explained

For convenience, BS 7567 (NTF v2.0) Levels 2 and 5 are referred to as NTF.

The purpose of this chapter and [chapter 2](#) is to:

- Provide a brief description of the presentation of Land-Form PROFILE in NTF: BS 7567 (NTF v2.0) Levels 2 and 5.
- Provide Licenced System Suppliers with as much detail as necessary to enable Land-Form PROFILE files in NTF to be easily understood and processed by application software.

The term data structure refers to the organisation and sequence of the records in the data file and not to the geographical topology of the data.

An overview of Land-Form PROFILE in NTF

Land-Form PROFILE is supplied in the British Standard national format common to the majority of Ordnance Survey's digital map data products – namely NTF – and is transferred in Level 2 for contours and Level 5 for DTMs.

An overview of the data structure of a Land-Form PROFILE data file is shown in diagrammatic form in figure 3. The convention used for this diagram is in the industry standard adopted for Jackson Structured Programming (JSP).

The British Standard for NTF stipulates the following for **Level 2**:

The main purpose of this level is to permit the addition of many attributes to the lines and points. Text may be linked to a feature as an attribute.

Level 2 also introduces information about the data in the form of quality records. The British Standard for NTF stipulates the following for **Level 5**:

This is a user-definable format and is intended mainly for highly specialised datasets, such as those that contain complex semantic relationships.

Level 5 carries a data dictionary comprising data description and data format records and is the point at which NTF becomes self-documenting.

The governing body for the industry standard NTF is the British Standards Institution (BSI).

BSI British Standards
389 Chiswick High Road
LONDON
W4 4AL

Phone: +44 (0)20 8996 9001
Fax: +44 (0)20 8996 7001
Email: cservices@bsigroup.com

Full details of the British Standard can be accessed through the British Standards Institutions web site at: www.bsigroup.com/en/Standards-and-Publications.

Any queries relating to the Land-Form PROFILE product should be referred to Customer Services at the address given in [Contact details](#) at the beginning of this user guide.

Conventions used in this user guide

Certain conventions are adopted as an aid to interpretation. In some cases the convention is dropped where the context is self-evident.

[] Square brackets are placed around record names, for example, [VOLHDREC].

[] 99 A two-digit number following square brackets denotes the record descriptor which uniquely identifies the record name between the brackets.

{ } A pair of braces denote field names, for example, {REC_DESC} is the record descriptor field.

<S> This is the space character (ASCII code 32).

<3S> This denotes three successive space characters.

- % The percentage character denotes end of record (ASCII code 37).
- | This denotes repeating fields (ASCII code 124).

Data overview

File structure

An overview of the data format of a Land-Form PROFILE data file in NTF is shown below. The convention used for this diagram is in the industry standard adopted for Jackson Structured Programming.

Figure 3: Overall logical structure of an NTF file

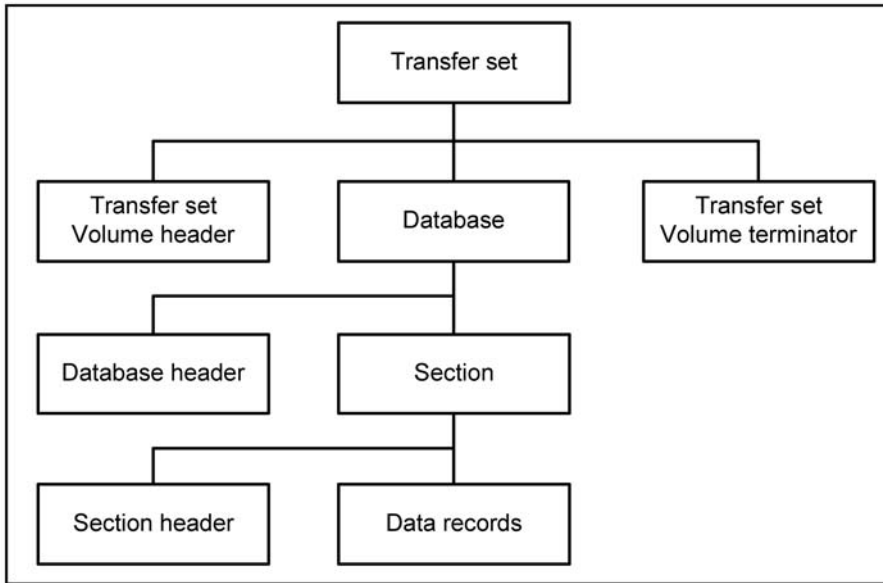

Physical file structure of an NTF file

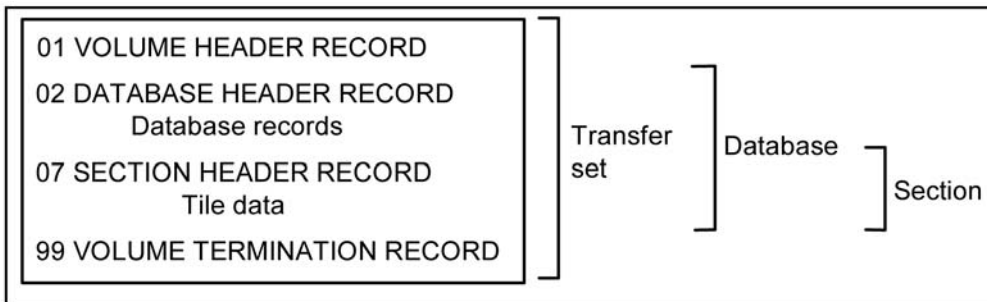

Version management

Product copyright

The copyright date is shown in the {COPYRIGHT} field of the [Section Header Record](#) [SECHREC].

NTF version

The current version is (NTF v2.0) **Level 2** for contours and (NTF v2.0) **Level 5** for DTMs. Version 2.0 will be supplied until further notice.

The NTF version is indicated by the {NTFVER} field of the [Volume Header Record](#) [VOLHDREC]. The effective date of the definition of NTF v2.0 in Land-Form PROFILE is 15 May 1992 and is indicated by the {DDATE} field of the [Database Header Record](#) [DBHREC].

General

Record size

NTF data is written to the output device in variable length records, with a maximum record length of 80 characters, which includes {CONT_MARK} and {EOR}.

Continuation mark {CONT_MARK} and Continuation Record [CONTREC]

Continuation records are used where the maximum physical record length of 80 characters does not permit a logical record to be transferred wholly within one physical record. The presence of a following Continuation Record is indicated by the value of the continuation mark {CONT_MARK}, which immediately precedes the record terminator {EOR}. The value of {CONT_MARK} is 1 if there is a Continuation Record present and 0 if there is not. A Continuation Record may be identified by the first two characters in the record which will be 00. It will adopt the field layout of the physical record it is continuing.

Record terminator {EOR}

The end of record terminator is the per cent (%) (ASCII 37).

Transfer set

A transfer set normally equates to a single file except where continuation volumes are used when the transfer set exceeds the capacity of the medium. The data the customer receives is in one or more transfer sets.

Supply of data on formatted media

The transfer set has one dataset and one section. One or more transfer sets are put onto the medium.

If your order is larger than the capacity of the medium, it is put onto two or more of that medium.

Continuation volumes are only used if a transfer set is larger than the capacity of the medium.

Formatted media (transfer set less than media capacity)

01	VOLUME HEADER RECORD
02	DATABASE HEADER RECORD Database records
07	SECTION HEADER RECORD Tile 1 data
99	VOLUME TERMINATION RECORD
01	VOLUME HEADER RECORD
02	DATABASE HEADER RECORD Database records
07	SECTION HEADER RECORD Tile 2 data
99	VOLUME TERMINATION RECORD
	and so on Tile n data
99	VOLUME TERMINATION RECORD

Transfer set structure

Volume records

Each transfer set starts with a compulsory [Volume Header Record](#) [VOLHDREC] and terminates with a compulsory [Volume Terminator Record](#) [VOLTERM].

As a transfer set may span one or more volumes, {VOLNUM} within the [Volume Header Record](#) will indicate which volume in the sequence of volumes within the transfer set it is. Similarly, the [Volume Termination Record](#) may end either a single volume or a complete transfer set. A field similar to the continuation mark is used to indicate completion or continuation.

Database records

Database records transfer information common to all data and their presentation in the subsequent section(s).

An NTF transfer set will comprise one database. The database commences with a [Database Header Record](#) [DBHREC] which sets up the database. It will be followed by a number of other database records as indicated below.

Database Header Record [DBHREC]

This mandatory record indicates the commencement of a database and gives details of:

- The database name.
- NTF release date.
- Feature classification table name.
- Release data which applies to the whole transfer set.

Attribute Description Record [ATTDESC]

These records list and give descriptions of the attributes that can be applied to features within the transfer set. These records are not present in Land-Form PROFILE DTMs.

Feature Classification Record [FEATCLASS]

These records list and give descriptions of all possible feature codes for the transfer set. These records are not present in Land-Form PROFILE DTMs.

Data Description Record [DATADESC]

These records list and define new data fields used within new records defined in [Data Format Records](#) [DATAFMT]. These records are not present in Land-Form PROFILE contours.

Data Format Record [DATAFMT]

These records list and define new records used to transfer data in the DTM. These records are not present in Land-Form PROFILE contours.

Section records

The section records contain the data within the map file. The section starts with the [Section Header Record](#) [SECHREC] followed by the section data records.

Section Header Record [SECHREC]

This mandatory record starts a section. It contains information and parameters essential for understanding, interpreting and processing some of the fields within the data. It establishes the unit of measure for x, y and z coordinates, origins and other constants.

Section data records

These contain all the features within the section. The records used within Land-Form PROFILE contours and DTMs differ ([Record structures section](#) of the Technical Specification).

AREA_AMND field

The {AREA_AMND} field in NTF appears in the [Section Header Record](#) [SECHREC] in Land-Form PROFILE contours and in the [Grid Header Record](#) [GRIDHREC] in Land-Form PROFILE DTMs.

In DXF, the field value is shown in footnote 8.

This field indicates the km squares of the map that contain change since the previous revision. Each km square is given a successive power of 2, that is 1, 2, 4, 8 and so on, numbering them from 1 to 16777216. The {AREA_AMND} value is obtained by adding together the numbers of the km squares containing revised data – giving a value between 1 and 33554431. The diagrams below show how these values are worked out.

A	B	C	D	E
F	G	H	I	J
K	L	M	N	O
P	Q	R	S	T
U	V	W	X	Y

Km square	Value	Km square	Value
A	1	N	8192
B	2	O	16384
C	4	P	32768
D	8	Q	65536
E	16	R	131072
F	32	S	262144
G	64	T	524288
H	128	U	1048576
I	256	V	2097152
J	512	W	4194304
K	1024	X	8388608
L	2048	Y	16777216
M	4096		

Examples:

Km square(s) with change:

- A
- A, B, F, G, L, M, Q, R, V, W
- All

{AREA_AMND} value:

- 1
- 6494307
- 33554431

Structure of Land-Form PROFILE contours in NTF

Land-Form PROFILE contours have a vector point and line data structure: within this structure a feature may be a point or a line. Each feature is free-standing; that is its topological relationship to any other feature is not expressed in the data. Features are classified by type and each type is placed as a separate feature code, these are listed in [Land-Form PROFILE explained](#) section of the user guide.

Record configuration for Land-Form PROFILE contours data in NTF

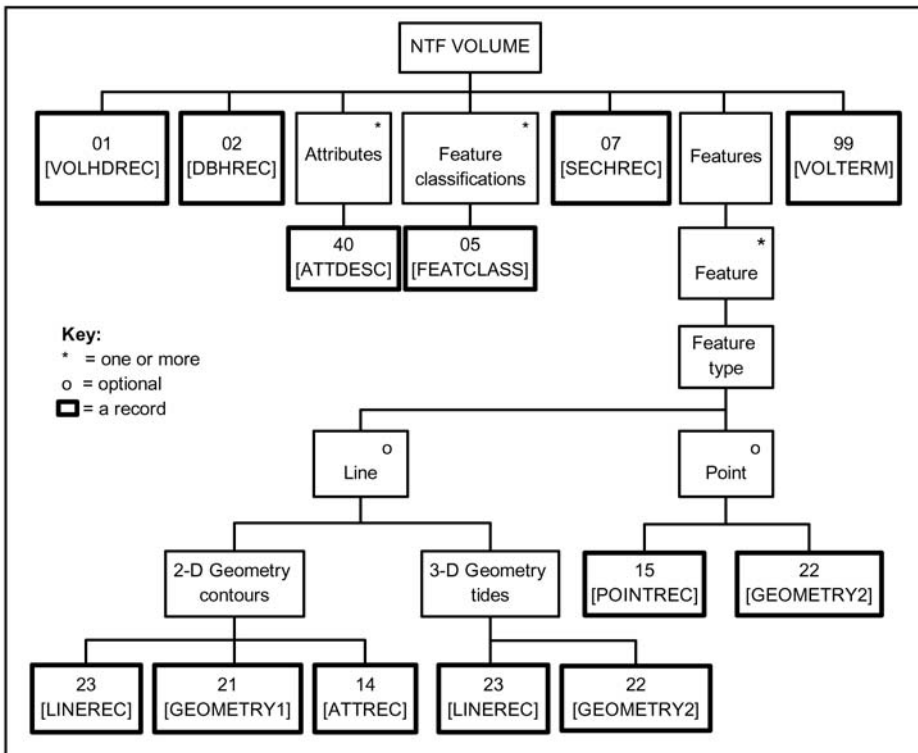

Section data records for contours

These records contain all the features within the section and are listed as they apply to Land-Form PROFILE contours:

- **Point Record [POINTREC]** contains attribute information for point features.
- **Line Record [LINEREC]** contains attribute information for line features.
- **Attribute Record [ATTREC]** contains the height value for a contour.
- **Geometry Records** contain the coordinate position(s) of features. Geometry records for point features will contain one coordinate triple whilst those for line features will contain two or more coordinate pairs or triples:
- **[GEOMETRY1] Records**, which contain x and y coordinates, are used for contours.
- **[GEOMETRY2] Records**, which contain x, y, and z coordinates, are used for spot and air heights, and tide lines.
- **Geometry continuation records** will be used where required.

Examples

Spot heights and air heights are shown as three-dimensional geometry and will be depicted using the following records:

	Description in NTF
POINT RECORD	[POINTREC]
GEOMETRY RECORD	[GEOMETRY2]

Contours are shown as two-dimensional geometry with height held as an attribute and will be depicted by the use of the following records:

	Description in NTF
LINE RECORD	[LINEREC]
GEOMETRY RECORD	[GEOMETRY1]
GEOMETRY CONTINUATION RECORD	[CONTREC]
ATTRIBUTE RECORD	[ATTREC]

Tide lines are shown as three-dimensional geometry and will be depicted by the use of the following records:

	Description in NTF
LINE RECORD	[LINEREC]
GEOMETRY RECORD	[GEOMETRY2]
GEOMETRY CONTINUATION RECORD	[CONTREC]

Coordinate referencing system for contours

Abbreviated NG coordinates are supplied, and these are given in centimetres. The coordinates (eastings, northings and height) have a field width of 6 (as indicated in the {XYLEN} and {ZLEN} fields in the [Section Header Record \[SECHREC\]](#)), not the NTF default width of 10. Leading zeros will be present to complete the field width. Negative values for height may be present; in which case the minus sign appears as the first character.

All eastings and northings are measured from the south-west corner of the 5 km by 5 km square tile.

Full horizontal NG coordinates are calculated by using the {XY_MULT}, {X_ORIG} and {Y_ORIG} values in the [Section Header Record](#) [SECHREC] 07, and the conversion formulae below:

$$X = (\{XY_MULT\} \times \{X_COORD\}) + \{X_ORIG\}$$

$$Y = (\{XY_MULT\} \times \{Y_COORD\}) + \{Y_ORIG\}$$

where {X_ORIG} and {Y_ORIG} are additive constants, always added to {X_COORD} and {Y_COORD} respectively, whilst {XY_MULT} is a multiplication factor applied to the coordinates before the addition of {X_ORIG} and {Y_ORIG}.

In a similar manner, using the {Z_MULT} value in the [Section Header Record](#) [SECHREC] 07, heights may be expressed in metres above datum using the following conversion formulae:

For [Three-Dimensional Geometry Records](#) [GEOMETRY2], that is for spot heights, air heights and tide lines:

$$Z = \{Z_MULT\} \times \{Z_COORD\}$$

From [Attribute Records](#) [ATTREC], that is for contours:

$$Z = \{Z_MULT\} \times \{VALUE\}$$

Structure of Land-Form PROFILE DTMs in NTF

The overall structure of a Land-Form PROFILE DTM data file in NTF, and of the transfer set(s) contained within it, is the same as described in [Land-Form PROFILE explained](#) section of the user guide.

Unlike Land-Form PROFILE contours, there are no point or line features supplied for DTMs. Instead, the 5 km by 5 km tile is equally divided by a 10 metre grid and the heights are represented as values at the intersections of this grid.

Record configuration for Land-Form PROFILE DTM data in NTF

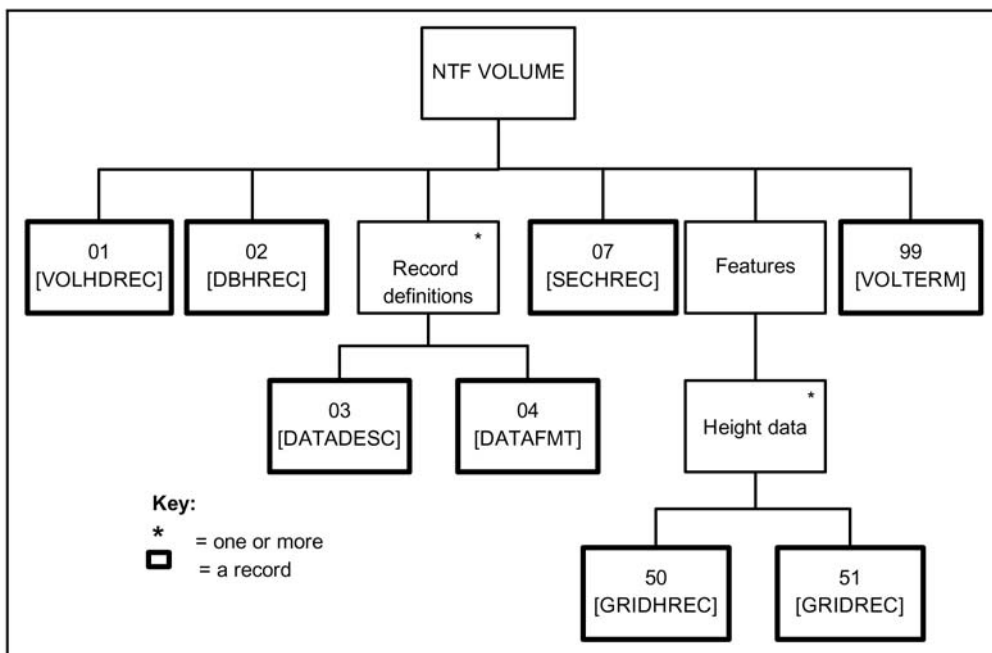

Section data records for DTMs

Database records for DTMs

Following the mandatory [Database Header Record](#) [DBHREC], two types of database record are used to define section data records used within the section records part of the file:

- **Data Description Record [DATADESC]**
 These records list and define new data fields used within new records defined in [Data Format Records](#) [DATAFMT].
- **Data Format Record [DATAFMT]**
 These records list and define new records used to transfer data in the DTM.

Section records for DTMs

Following the mandatory [Section Header Record](#) [SECHREC], two types of section record, defined in the database records part of the file, are used to transfer the height information:

- **Grid Header Record [GRIDHREC]**
This record describes the 10 metre grid structure.
- **Grid Data Record [GRIDREC]**
Each [Grid Data Record](#) gives the 501 height values (reading south to north) for one column of the grid. The first [Grid Data Record](#) in the file describes the westernmost column, that is the western edge of the tile. Each subsequent record details the next column eastwards until the 501st and final record lists the height values for the eastern edge of the tile.

Coordinate reference system for DTMs

Abbreviated National Grid coordinates are supplied. The coordinates (eastings, northings and height) have a field width of 5 (as indicated in the {XYLEN} and {ZLEN} fields in the [Section Header Record](#) [SECHREC]), not the NTF default width of 10. Leading zeros will be present to complete the field width. Negative values for height may be present; in which case the minus sign appears as the first character.

The [Grid Header Record](#) contains the horizontal coordinates of the origin of the DTM in the {X_COORD} and {Y_COORD} fields. Full horizontal NG coordinates of the origin may be calculated by using the {XY_MULT}, {X_ORIG} and {Y_ORIG} values in the [Section Header Record](#) [SECHREC] 07, and the conversion formulae below:

$$XO = (\{XY_MULT\} \times \{X_COORD\}) + \{X_ORIG\}$$

$$YO = (\{XY_MULT\} \times \{Y_COORD\}) + \{Y_ORIG\}$$

where XO and YO are the full NG coordinates of the origin and {X_ORIG} and {Y_ORIG} are additive constants, always added to {X_COORD} and {Y_COORD} respectively, whilst {XY_MULT} is a multiplication factor applied to the coordinates before the addition of {X_ORIG} and {Y_ORIG}.

The [Grid Data Records](#) contain no horizontal coordinates. Instead the horizontal position of an individual height value from the south-west corner of the DTM may be calculated from the field {GRID_ID} and the position (or row) of the height value within the [GRIDREC] record as follows:

$$XH = (\{GRID_ID\} - 1) \times \{COL_INTRVL\}$$

$$YH = (\text{number of row} - 1) \times \{ROW_INTRVL\}$$

where XH and YH are the abbreviated NG coordinates of the height value, {COL_INTRVL} and {ROW_INTRVL} are respectively the fields in the [Grid Header Record](#) [GRIDHREC] giving the distance in metres between the columns (Grid Records) identified by {GRID_ID} and the distance between height values (rows) within each Grid Record.

To obtain the full NG coordinates of the height value, add the XH and YH values of the height just obtained to the XO and YO values of the origin calculated above.

The height above Ordnance Survey datum, or specified datum in metres of a height value may be calculated by using the {Z_MULT} value in the [Section Header Record](#) [SECHREC] 07 using the following conversion formula:

$$\text{For } \text{Grid Data Records [GRIDREC]}, Z = \{Z_MULT\} \times \{Z_COORD\}$$

Chapter 2 Record structures for the transfer of Land-Form PROFILE in NTF

NTF record list for Land-Form PROFILE contours

This list comprises the valid record types used in the Land-Form PROFILE NTF transfer set.

Descriptor	Description	Record name
01	Volume Header Record – defines the donor and data type.	[VOLHDREC]
02	Database Header Record – transfers data about the database.	[DBHREC]
05	Feature Classification Record – defines data classifications	[FEATCLASS]
07	Section Header Record – coordinate and structure types, unit scale, factors, and so on.	[SECHREC]
14	Attribute Record – defines the attributes for line and point records.	[ATTREC]
15	Point Record – identifies the definition of node points.	[POINTREC]
21	Two-Dimensional Geometry Record – defines the two-dimensional geometry for a link or node.	[GEOMETRY1]
22	Three-Dimensional Geometry Record – defines the three-dimensional geometry for a link or node.	[GEOMETRY2]
23	Line Record – identifies the definition of a link.	[LINEREC]
40	Attribute Description Record – defines attribute descriptions and their fields	[ATTDESC]
99	Volume Terminator Record – defines the end of the transfer set.	[VOLTERM]

Land-Form PROFILE contours

Volume Header Record [VOLHDREC] 01 for Land-Form PROFILE contours

Field	Position	Format	Value example	Description
REC_DESC	01:02	A2	01	Volume Header Record identifier.
DONOR	03:22	A20	ORDNANCE SURVEY <5S>	
RECIPIENT	23:42	A20	<20S>	Not used.
TRANDATE	43:50	D8	19940120	Date of processing.
SERIAL	51:54	I4	0000	Not used.
VOLNUM	55:56	I2	01	Number of volume in transfer set.
NTFLEVEL	57:57	I1	2	NTF Level 2.
NTFVER	58:61	R4,2	0200	NTF Version 2.00.
NTFOR	62:62	A1	V	Variable length records.
EOR	63:63	A1	<S>	Defaults to % on formatted media.
DIVIDER	64:64	A1	\	Divider used to terminate variable length text fields.
CONT_MARK	65:65	I1	0	No continuation record.
EOR	66:66	A1	%	Record terminator.

Record example:

```
01ORDNANCE SURVEY                                1994012000000120200V \0%
.....|.....1.....|.....2.....|.....3.....|.....4.....|.....5.....|.....6.....|.....7.....|.....8
123456789012345678901234567890123456789012345678901234567890123456789012345678901234567890
.....|.....|.....|.....|.....|.....|.....|.....|.....|.....|.....|.....|.....|.....|.....|.....|
```

Template

Database Header Record [DBHREC] 02 for Land-Form PROFILE contours

Field	Position	Format	Value example	Description
REC_DESC	01:02	A2	02	Database Header Record identifier.
DBNAME	03:22	A20	L-F_PROFILE_CON<5S>	Database name, that is Land-Form PROFILE contours.
DDNAME	23:42	A20	DEFAULT_02.00<7S>	Standard NTF data dictionary name.
DDATE	43:50	D8	19920515	Date of standard data dictionary.
DDBASE	51:70	A20	<20S>	Not used.
DDBDATE	71:78	D8	00000000	Not used.
CONT_MARK	79:79	I1	1	Continuation record follows.
EOR	80:80	A1	%	Record terminator.

Continuation of Database Header Record

Field	Position	Format	Value example	Description
REC_DESC	01:02	A2	00	Continuation Record identifier.
FCNAME	03:22	A20	<20S>	Not used.
FCDATE	23:30	D8	00000000	Not used.
DQNAME	31:50	A20	<20S>	Not used.
DQDATE	51:58	D8	00000000	Not used.
DATA_MODEL	59:60	A2	02	Simple line or point data model (spaghetti).
CONT_MARK	61:61	I1	0	No continuation record.
EOR	62:62	A1	%	Record terminator.

Record example:

```
02L-F_PROFILE_CON      DEFAULT_01.00      19920515      000000001%
00                      00000000                      00000000020%
```

....1....2....3....4....5....6....7....8
123456789012345678901234567890123456789012345678901234567890123456789012345678901234567890								
....

Template

Feature Classification Record [FEATCLASS] 05 for Land-Form PROFILE contours

Field	Position	Format	Value example	Description
REC_DESC	01:02	A2	05	Feature Classification Record identifier.
FEAT_CODE	03:06	A4		Feature code defined (see record examples below).
CODE_COM	07:16	A10	<10S>	Not used.
STCLASS	17:36	A20	<20S>	Not used.
FEATDES	37:*	A*		Description of the feature code.
DIVIDER	*.*	A1	\	
CONT_MARK	*.*	I1	0	No continuation record.
EOR	*.*	A1	%	Record terminator.

Record examples:

```
050027 Spot Heights\0%
050071 Mean High Water\0%
050072 Mean Low Water\0%
050075 Contour\0%
051361 Index Contour\0%
051372 Air Height\0%
```

....1....2....3....4....5....6....7....8
1234567890123456789012345678901234567890123456789012345678901234567890123456789012345678901234567890								
....

Template

Section Header Record [SECHREC] 07 for Land-Form PROFILE contours

Field	Position	Format	Value example	Description
REC_DESC	01:02	A2	07	Section Header Record identifier.
SECT_REF	03:12	A10	SS78NE<4S>	Land-Form PROFILE sheet number.
COORD_TYP	13:13	I1	2	Defines rectangular coordinates.
STRUC_TYP	14:14	I1	1	Defines vector data.
XYLEN	15:19	I5	00006	Redefines {X_COORD}, {Y_COORD} to 6-digit fields.
XY_UNIT	20:20	I1	2	Defines units as metres.
XY_MULT	21:30	R10,3	000000010	Multiply X and Y coordinates by 0.010.
ZLEN	31:35	I5	00006	Redefines {Z_COORD} to 6-digit field.
Z_UNIT	36:36	I1	2	Defines units as metres.
Z_MULT	37:46	R10,3	000000010	Multiply Z coordinates by 0.010.
X_ORIG	47:56	I10	0000275000	NG eastings of map origin.
Y_ORIG	57:66	I10	0000185000	NG northings of map origin.
Z_DATUM	67:76	I10	0000000000	Defines which datum is used for height.
CONT_MARK	77:77	I1	1	Continuation record follows.
EOR	78:78	A1	%	Record terminator.

First continuation of Section Header Record

Field	Position	Format	Value example	Description
REC_DESC	01:02	A2	00	Continuation Record identifier.
XMIN	03:12	I10	0000000000	Abbreviated eastings of SW corner of tile.
YMIN	13:22	I10	0000000000	Abbreviated northings of SW corner of tile.
XMAX	23:32	I10	0000005000	Abbreviated eastings of NE corner of tile.
YMAX	33:42	I10	0000005000	Abbreviated northings of NE corner of tile.
XY_ACC	43:47	R5,2	00000	Not used.
Z_ACC	48:52	R5,2	00000	Not used.
SURV_DATE	53:60	D8	00000000	Not used.
LAST_AMND	61:68	D8	19940120	Date data last amended.
COPYRIGHT	69:76	D8	19940000	Effective copyright date.
CONT_MARK	77:77	I1	1	Continuation record follows.
EOR	78:78	A1	%	Record terminator.

Second continuation of Section Header Record

Field	Position	Format	Value example	Description
REC_DESC	01:02	A2	00	Continuation Record identifier.
SQNAME	03:22	A20	<20S>	Not used.
SQDATE	23:30	D8	00000000	Not used.
SCALE	31:39	I9	000010000	Notional scale, that is, 1:10 000 scale.
GRID_OR_X	40:49	R10,3	0000000000	Not used.
GRID_OR_Y	50:59	R10,3	0000000000	Not used.
PROJ_OR_LAT	60:67	R8,1	00000000	Not used.
PROJ_OR_LONG	68:75	R8,1	00000000	Not used.
CONT_MARK	76:76	I1	1	Continuation record follows.
EOR	77:77	A1	%	Record terminator.

Third continuation of Section Header Record

Field	Position	Format	Value example	Description
REC_DESC	01:02	A2	00	Continuation Record identifier.
SPHER_NAME	03:12	A10	<10S>	Not used.
MAJOR_AXIS	13:22	R10,3	0000000000	Not used.
ECCENTRICITY	23:30	R8,2	00000000	Not used.
FLATTENING	31:35	R5,2	00000	Not used.
PROJECTION	36:45	A10	<10S>	Not used.
PARAMETER_1	46:53	I8	00000000	Not used.
P_TYPE	54:54	A1	<S>	Not used.
PARAMETER_2	55:62	I8	00000000	Not used.
HO_UNIT_COUNT	63:66	I4	0000-9999	A cumulative count of the change to the map.
DATE_LST_CHANG	67:74	D8	YYYYMMDD	Date of last change.
CONT_MARK	75:75	I1	1	Continuation record follows.
EOR	76:76	A1	%	Record terminator.

Fourth continuation of Section Header Record

Field	Position	Format	Value example	Description
REC_DESC	01:02	I2	00	Continuation Record identifier.
AREA_AMND	03:10	I8	12345678	Location of change indicator (see page 24 for an explanation of this field).
CONT_MARK	11:11	I1	0	No continuation record.
EOR	12:12	A1	%	Record terminator.

Record example:

```
07SS78NE      21000062000000001000006200000000100000275000000018500000000000001%
0000000000000000000000000000050000000050000000000000000000019940120199400001%
00                0000000000001000000000000000000000000000000000001%
00                00000000000000000000000000000000000000000000000001%
00123456780%
```

.....1.....2.....3.....4.....5.....6.....7.....8
1234567890	1234567890	1234567890	1234567890	1234567890	1234567890	1234567890	1234567890	1234567890
.....

Template

Attribute Record [ATTREC] 14 for Land-Form PROFILE contours

Field	Position	Format	Value example	Description
REC_DESC	01:02	A2	14	Attribute Record identifier.
ATT_ID	03:08	I6	000000	Not used.
VAL_TYPE	09:10	A2	HT	Attribute mnemonic.
VALUE	11:16	I6	004000	Height of contour.
CONT_MARK	17:17	I1	0	No continuation record.
EOR	18:18	A1	%	Record terminator.

Record example:

```
14000000HT0040000%
```

.....1.....2.....3.....4.....5.....6.....7.....8
1234567890	1234567890	1234567890	1234567890	1234567890	1234567890	1234567890	1234567890	1234567890
.....

Template

Point Record [POINTREC] 15 for Land-Form PROFILE contours

Field	Position	Format	Value example	Description
REC_DESC	01:02	A2	15	Point Record identifier.
POINT_ID	03:08	I6	000001 to 999999	Feature serial number.
VAL_TYPE	09:10	A2	<2S>	Not used.
VALUE	11:16	A6	<6S>	Not used.
FEAT_CODE	17:20	A4	0027 or 1372	Feature code.
SECURITY	21:21	A1	<S>	Not used.
CHG_TYPE	22:22	A1	<S>	Not used.
CHG_DATE	23:28	D6	000000	Not used.
QLABEL	29:29	A1	<S>	Not used.
SURV_DATE	30:35	D6	000000	Not used.
CONT_MARK	36:36	I1	0	No continuation record.
EOR	37:37	A1	%	Record terminator.

Record example:

```
15001314      1372  000000 0000000%
.....|.....1.....|.....2.....|.....3.....|.....4.....|.....5.....|.....6.....|.....7.....|.....8
123456789012345678901234567890123456789012345678901234567890123456789012345678901234567890
.....|.....|.....|.....|.....|.....|.....|.....|.....|.....|.....|.....|.....|.....|.....|.....|
```

Template

Two-dimensional Geometry Record [GEOMETRY1] 21 for Land-Form PROFILE contours

Field	Position	Format	Value example	Description
REC_DESC	01:02	A2	21	Two-dimensional Geometry Record identifier.
GEOM_ID	03:08	I6	000000	Not used.
GTYPE	09:09	I1	2	Defines as line geometry.
NUM_COORD	10:13	I4	0001 to 9999	Number of coordinate pairs that follow.
X_COORD	14:*	I6	000000 to 500000	Easting.
Y_COORD	*.*	I6	000000 to 500000	Northing.
QPLAN	*.*	A1	<S>	Not used.
CONT_MARK	*.*	I1	0 or 1	No continuation record or continuation record follows.
EOR	*.*	A1	%	Record terminator.

Record example:

```
2100000020010114150161900 113650161950 112150162150 111400162250 110750162200 1%
00109500162300 109150162300 108750162350 105650161650 104450161400 0%
.....|.....1.....|.....2.....|.....3.....|.....4.....|.....5.....|.....6.....|.....7.....|.....8
123456789012345678901234567890123456789012345678901234567890123456789012345678901234567890
.....|.....|.....|.....|.....|.....|.....|.....|.....|.....|.....|.....|.....|.....|.....|.....|
```

Template

NOTE: The group of fields {X_COORD}, {Y_COORD} and {QPLAN} may repeat to end of physical record and through one or more continuation records {NUM_COORD} times.

Three-Dimensional Geometry Record [GEOMETRY2] 22 for Land-Form PROFILE contours

Field	Position	Format	Value example	Description
REC_DESC	01:02	A2	22	Three-dimensional Geometry Record identifier.
GEOM_ID	03:08	I6	000000	Not used.
GTYPE	09:09	I1	1 or 2	Defines as point or line geometry (1 = point, 2 = line).
NUM_COORD	10:13	I4	0001 to 9999	Number of coordinate triples that follow.
X_COORD	14:*	I6	000000 to 500000	Easting.
Y_COORD	*.*	I6	000000 to 000000	Northing.
QPLAN	*.*	A1	<S>	Not used.
Z_COORD	*.*	I6	-01000 to 140000	Height of vertex.
QHT	*.*	A1	<S>	Not used.
CONT_MARK	*.*	I1	0 or 1	No continuation record or continuation record follows.
EOR	*.*	A1	%	Record terminator.

Record example:

```
2200000010001044750378850 -00240 0%
2200000020005499375401160 000221 499005401470 000221 498830401620 000221 1%
00498660401780 000221 498355402135 000221 0%
```

....1....2....3....4....5....6....7....8
123456789012345678901234567890123456789012345678901234567890123456789012345678901234567890								
....

Template

NOTE: The group of fields {X_COORD}, {Y_COORD}, {QPLAN}, {Z_COORD} and {QHT} may repeat to end of physical record and through one or more continuation records {NUM_COORD} times.

Line Record [LINEREC] 23 for Land-Form PROFILE contours

Field	Position	Format	Value example	Description
REC_DESC	01:02	A2	23	Line Record identifier.
LINE_ID	03:08	I6	000001-999999	Feature serial number.
VAL_TYPE	09:10	A2	<2S>	Not used.
VALUE	11:16	A6	<6S>	Not used.
FEAT_CODE	17:20	A4	0071, 0072, 0075 or 1361	Feature code.
SECURITY	21:21	A1	<S>	Not used.
CHG_TYPE	22:22	A1	<S>	Not used.
CHG_DATE	23:28	D6	000000	Not used.
QLABEL	29:29	A1	<S>	Not used.
SURV_DATE	30:35	D6	000000	Not used.
CONT_MARK	36:36	I1	0	No continuation record.
EOR	37:37	A1	%	Record terminator.

Record example:

```
23000223          0075  000000 0000000%
```

....1....2....3....4....5....6....7....8
123456789012345678901234567890123456789012345678901234567890123456789012345678901234567890								
....

Template

Attribute Description Record [ATTDESC] 40 for Land-Form PROFILE contours

Field	Position	Format	Value example	Description
REC_DESC	01:02	A2	40	Attribute Description Record identifier.
VAL_TYPE	03:04	A2	HT	Attribute mnemonic, for example, height.
FWIDTH	05:07	A3	006	Field width of attribute value.
FINTER	08:12	A5	I6<3S>	Interpretation of field, for example, I6.
ATT_NAME	13:*	A*	HEIGHT	Name given to attribute.
DIVIDER	*.*	A1	\	
FDESC	*.*	A*	HEIGHT IN CM	Textual description of attribute.
DIVIDER	*.*	A1	\	
CONT_MARK	*.*	I1	0	No continuation record.
EOR	*.*	A1	%	Record terminator.

Record example:

```
40HT006I6 HEIGHT\HEIGHT IN CM\0%
....|....1....|....2....|....3....|....4....|....5....|....6....|....7....|....8
12345678901234567890123456789012345678901234567890123456789012345678901234567890
....|....|....|....|....|....|....|....|....|....|....|....|....|....|....|....|
```

Template

Volume Terminator Record [VOLTERM] 99 for Land-Form PROFILE contours

Field	Position	Format	Value example	Description
REC_DESC	01:02	A2	99	Volume Terminator Record identifier.
FREE_TEXT	03:*	A*		See NOTE below.
CONT_VOL	*+1:~+1	I1	0 or 1	No continuation volume or continuation volume follows.
EOR	*+2:~+2	A1	%	Record terminator.

NOTES:

If there are further volume(s) to follow then the FREE_TEXT field comprises the following message:

'End Of Volume (nn) Transfer Set Continues On Volume (nn+1)'

If there are no further volumes then the FREE_TEXT field will read:

'End Of Transfer Set'

* = variable integer.

Record examples:

```
99End Of Volume 01 Transfer Set Continues On Volume 021%
....|....1....|....2....|....3....|....4....|....5....|....6....|....7....|....8
12345678901234567890123456789012345678901234567890123456789012345678901234567890
....|....|....|....|....|....|....|....|....|....|....|....|....|....|....|....|
```

Template

```
99End Of Transfer Set0%
....|....1....|....2....|....3....|....4....|....5....|....6....|....7....|....8
12345678901234567890123456789012345678901234567890123456789012345678901234567890
....|....|....|....|....|....|....|....|....|....|....|....|....|....|....|....|
```

Template

NTF record list for Land-Form PROFILE DTMs

This list comprises the valid record types used in the Land-Form PROFILE NTF transfer set.

Descriptor	Description	Record name
01	Volume Header Record – defines the donor and data type.	[VOLHDREC]
02	Database Header Record – transfers data about the database.	[DBHREC]
03	Data Description Record – transfers data dictionary field definitions.	[DATADESC]
04	Data Format Record – transfers data dictionary record definitions.	[DATAFMT]
50	Grid Header Record – defines DTM grid.	[GRIDHREC]
51	Grid Data Record – defines DTM height values for grid.	[GRIDREC]
99	Volume Terminator Record – defines the end of the transfer set.	[VOLTERM]

Land-Form PROFILE DTMs in NTF

Volume Header Record [VOLHDREC] 01 for Land-Form PROFILE DTMs

Field	Position	Format	Value example	Description
REC_DESC	01:02	A2	01	Volume Header Record identifier.
DONOR	03:22	A20	ORDNANCE SURVEY <5S>	
RECIPIENT	23:42	A20	<20S>	Not used.
TRANDATE	43:50	D8	19940120	Date of processing.
SERIAL	51:54	I4	0000	Not used.
VOLNUM	55:56	I2	01	Number of volume in transfer set.
NTFLEVEL	57:57	I1	5	NTF Level 5.
NTFVER	58:61	R4,2	0200	NTF Version 2.00.
NTFOR	62:62	A1	V	Variable length records.
EOR	63:63	A1	<S>	Defaults to % on formatted media.
DIVIDER	64:64	A1	\	Divider used to terminate variable length text fields.
CONT_MARK	65:65	I1	0	No continuation record.
EOR	66:66	A1	%	Record terminator.

Record example:

```
01ORDNANCE SURVEY                1994012000000150200V \0%
```

....1....2....3....4....5....6....7....8
1234567890	1234567890	1234567890	1234567890	1234567890	1234567890	1234567890	1234567890	1234567890
....

Template

Database Header Record [DBHREC] 02 for Land-Form PROFILE DTMs

Field	Position	Format	Value example	Description
REC_DESC	01:02	A2	02	Database Header Record identifier.
DBNAME	03:22	A20	L-F_PROFILE_DTM<5S>	Database name, that is Land-Form PROFILE DTM.
DDNAME	23:42	A20	DEFAULT_02.00<7S>	Standard NTF data dictionary name.
DDATE	43:50	D8	19920515	Date of standard data dictionary.
DDBASE	51:70	A20	<20S>	Not used.
DDBDATE	71:78	D8	00000000	Not used.
CONT_MARK	79:79	A1	1	Continuation record follows.
EOR	80:80	A1	%	Record terminator.

Continuation of Database Header Record

Field	Position	Format	Value example	Description
REC_DESC	01:02	A2	00	Continuation Record identifier.
FCNAME	03:22	A20	<20S>	Not used.
FCDATE	23:30	D8	00000000	Not used.
DQNAME	31:50	A20	<20S>	Not used.
DQDATE	51:58	D8	00000000	Not used.
DATA_MODEL	59:60	A2	00	Data model type – undefined model.
CONT_MARK	61:61	I1	0	No continuation record.
EOR	62:62	A1	%	Record terminator.

Record example:

```

02L-F_PROFILE_DTM      DEFAULT_02.00      19920515      000000001%
00                      00000000          000000000000%
.....|.....1.....|.....2.....|.....3.....|.....4.....|.....5.....|.....6.....|.....7.....|.....8
123456789012345678901234567890123456789012345678901234567890123456789012345678901234567890
.....|.....|.....|.....|.....|.....|.....|.....|.....|.....|.....|.....|.....|.....|.....|

```

Template

Data Description Record [DATADESC] 03 for Land-Form PROFILE DTMs

Field	Position	Format	Value example	Description
REC_DESC	01:02	A2	03	Data Description Record identifier.
FIELD_NAME	03:12	A10	GRID_REF	Name of field being defined (see examples for list of values).
FWIDTH	13:15	I3	010	Width of field being defined.
FINTER	16:20	A5	A10	Format description if fixed, A* if variable.
FDESC	21:*	A*	GRID REFERENCE	Field description.
DIVIDER	*.*	A1	\	
NO_DATA	*.*	A*	<10S>	Field value when no data available. {FWIDTH} wide.
DIVIDER	*.*	A1	\	
RANGE_MIN	*.*	A*	<10S>	Minimum value for data. {FWIDTH} wide.
DIVIDER	*.*	A1	\	
RANGE_MAX	*.*	A*	<10S>	Maximum value for data. {FWIDTH} wide.
DIVIDER	*.*	A1	\	
UNITS	*.*	A2	<2S>	Not used.
CONT_MARK	*.*	I1	1 or 0	Continuation record follows or no continuation record.
EOR	*.*	A1	%	Record terminator.

The following DATADESC records are used for Land-Form PROFILE DTM data:

```

03GRID_REF 010A10 GRID REFERENCE\ \ \ \ 0%
03N_COLUMNS 008I8 NUMBER OF COLUMNS IN DTM\00000000\00000501\00000501\ 0%
03N_ROWS 008I8 NUMBER OF ROWS IN DTM\00000000\00000501\00000501\ 0%
03COL_INTRVL004I4 COLUMN INTERVAL IN SAME UNITS AS X_COORD AND Y_COORD\0000\1%
000010\0010\ 0%
03ROW_INTRVL004I4 ROW INTERVAL IN SAME UNITS AS X_COORD AND Y_COORD\0000\1%
000010\00010\ 0%
03SURV METH 001A1 METHOD OF SURVEY\ \ \ \ 0%
03SURVEY 008D8 DATE OF SURVEY\00000000\ \ \ 0%
03CHAN METH 001A1 METHOD OF CHANGE\ \ \ \ 0%
03CHANGE 008D8 DATE OF CHANGE\00000000\ \ \ 0%
03GRID_ID 008I8 UNIQUE IDENTIFIER FOR [GRIDREC]\00000000\00000001\000005011%
00\ 0%
03N_Z_COORD 008I8 NUMBER OF Z COORDINATES IN [GRIDREC]\00000000\00000501\1%
0000000501\ 0%
03AREA_AMND 008I8 AREA WITH CHANGE\00000000\00000000\33554431\0%
03HO_UNIT CT004I4 UNITS OF CHANGE\0000\0000\9999\0%

```

....	1....	2....	3....	4....	5....	6....	7....	8
1234567890123456789012345678901234567890123456789012345678901234567890123456789012345678901234567890																
....	

Template

Data Format Record [DATAFMT] 04 for Land-Form PROFILE DTMs

Field	Position	Format	Value example	Description
REC_DESC	01:02	A2	04	Data Format Record identifier.
REC_TYPE	03:04	A2	50	{REC_DESC} of record being defined (see examples for list of values).
REC_NAME	05:14	A10	GRIDHREC<2S>	
NUM_FIELD	15:16	I2	12	Number of fields in the record.
FIELD_NAME	*.*	A10	GRID_REF<2S>	Corresponds to entry in {DATADESC} or BS 7567.
FUSE	*.*	A1	c or o	Use of field (c = compulsory, o = optional).
CONT_MARK	*.*	I1	1 or 0	Continuation record follows or no continuation record.
EOR	*.*	A1	%	Record terminator.

The following [DATAFMT] records will be used for PROFILE DTM data:

```

0450GRIDHREC 14REC_DESC cGRID_REF cX_COORD cY_COORD cN_COLUMNS c1%
00N_ROWS cCOL_INTRVLCROW_INTRVLC SURV_METH oSURVEY oCHAN_METH oCHANGE 1%
00oHO UNIT CToAREA AMND o0%
0451GRIDREC 04REC_DESC cGRID ID cN Z COORD c(Z COORD c) 0%

```

....1....2....3....4....5....6....7....8
123456789012345678901234567890123456789012345678901234567890123456789012345678901234567890								
....

Template

NOTE: The use of braces around any {FIELD_NAME} and {FUSE} entries indicates a repeating group of fields.

Section Header Record [SECHREC] 07 for Land-Form PROFILE DTMs

Field	Position	Format	Value example	Description
REC_DESC	01:02	A2	07	Section Header Record identifier.
SECT_REF	03:12	A10	SS78NE<4S>	Land-Form PROFILE sheet number.
COORD_TYP	13:13	I1	2	Defines rectangular coordinates.
STRUC_TYP	14:14	I1	1	Defines vector data.
XYLEN	15:19	I5	00005	Redefines {X_COORD}. {Y_COORD} to 5-digit fields.
XY_UNIT	20:20	I1	2	Defines units as metres.
XY_MULT	21:30	R10,3	0000001000	Multiply X and Y coords by 1.0.
ZLEN	31:35	I5	00005	Redefines {Z_COORD} to 5-digit field.
Z_UNIT	36:36	I1	2	Defines unit as metres.
Z_MULT	37:46	R10,3	0000000100	Multiply Z coords by 0.100.
X_ORIG	47:56	I10	0000275000	NG eastings of map origin.
Y_ORIG	57:66	I10	0000185000	NG northings of map origin.
Z_DATUM	67:76	I10	0000000000	Difference in height from Ordnance Survey Datum.
CONT_MARK	77:77	I1	1	Continuation record follows.
EOR	78:78	A1	%	Record terminator.

First continuation of Section Header Record

Field	Position	Format	Value example	Description
REC_DESC	01:02	A2	00	Continuation Record identifier.
XMIN	03:12	I10	0000000000	Abbreviated eastings of SW corner of tile.
YMIN	13:22	I10	0000000000	Abbreviated northings of SW corner of tile.
XMAX	23:32	I10	0000005000	Abbreviated eastings of NE corner of tile.
YMAX	33:42	I10	0000005000	Abbreviated northings of NE corner of tile.
XY_ACC	43:47	R5,2	00000	Not used.
Z_ACC	48:52	R5,2	00000	Not used.
SURV_DATE	53:60	D8	00000000	Not used.
LAST_AMND	61:68	D8	19940120	Date data last amended.
COPYRIGHT	69:76	D8	19940000	Effective copyright date.
CONT_MARK	77:77	I1	1	Continuation record follows.
EOR	78:78	A1	%	Record terminator.

Second continuation of Section Header Record

Field	Position	Format	Value example	Description
REC_DESC	01:02	A2	00	Continuation Record identifier.
SQNAME	03:22	A20	<20S>	Not used.
SQDATE	23:30	D8	00000000	Not used.
SCALE	31:39	I9	000010000	Notional scale, that is 1:10 000 scale.
GRID_OR_X	40:49	R10,3	0000000000	Not used.
GRID_OR_Y	50:59	R10,3	0000000000	Not used.
PROJ_OR_LAT	60:67	R8,1	00000000	Not used.
PROJ_OR_LONG	68:75	R8,1	00000000	Not used.
CONT_MARK	76:76	I1	1	Continuation record follows.
EOR	77:77	A1	%	Record terminator.

Third continuation of Section Header Record

Field	Position	Format	Value example	Description
REC_DESC	01:02	A2	00	Continuation Record identifier.
SPHER_NAME	03:12	A10	<10S>	Not used.
MAJOR_AXIS	13:22	R10,3	0000000000	Not used.
ECCENTRICITY	23:30	R8,2	00000000	Not used.
FLATTENING	31:35	R5,2	00000	Not used.
PROJECTION	36:45	A10	<10S>	Not used.
PARAMETER_1	46:53	I8	00000000	Not used.
P_TYPE	54:54	A1	<S>	Not used.
PARAMETER_2	55:62	I8	00000000	Not used.
CONT_MARK	63:63	I1	0	No continuation record.
EOR	64:64	A1	%	Record terminator.

Record example:

```

07SS78NE      21000062000000001000006200000000100000275000000018500000000000001%
00000000000000000000000000000005000000000500000000000000000000000000000019940120199400001%
00              0100000000000100000000000000000000000000000000000000000000000001%
00              0000000000000000000000000000000000000000000000000000000000000000%
.....|.....1.....|.....2.....|.....3.....|.....4.....|.....5.....|.....6.....|.....7.....|.....8
123456789012345678901234567890123456789012345678901234567890123456789012345678901234567890
.....|.....|.....|.....|.....|.....|.....|.....|.....|.....|.....|.....|.....|.....|.....|.....|

```

Template

Grid Header Record [GRIDHREC] 50 for Land-Form PROFILE DTMs

Field	Position	Format	Value example	Description
REC_DESC	01:02	A2	50	Grid Header Record identifier.
GRID_REF	03:12	A10	SS78NE<4S>	Map sheet number.
X_COORD	13:17	I5	00000	Origin of DTM relative to {X_ORIG}.
Y_COORD	18:22	I5	00000	Origin of DTM relative to {Y_ORIG}.
N_COLUMNS	23:30	I8	00000501	Number of columns in DTM.
N_ROWS	31:38	I8	00000501	Number of rows in DTM.
COL_INTRVL	39:42	I4	0010	X grid interval in metres.
ROW_INTRVL	43:46	I4	0010	Y grid interval in metres.
SURV_METH	47:47	A1	<S>	Not used.
SURVEY	48:55	D8	00000000	Date of survey.
CHAN_METH	56:56	A1	<S>	Not used.
CHANGE	57:64	D8	19940516	Date of change.
HO_UNIT_CT	65:68	I4	0032	A cumulative count to the change of the map.
AREA_AMND	69:76	I8	12345678	Location of change indicator (Structure of Land-Form PROFILE section) for an explanation of this field).
CONT_MARK	77:77	I1	0	No continuation record.
EOR	78:78	A1	%	Record terminator.

Record example:

```
50SS78NE 0000000000000005010000050100100010 00000000 199405160032123456780%
.....|.....1.....|.....2.....|.....3.....|.....4.....|.....5.....|.....6.....|.....7.....|.....8
123456789012345678901234567890123456789012345678901234567890123456789012345678901234567890
.....|.....|.....|.....|.....|.....|.....|.....|.....|.....|.....|.....|.....|.....|.....|.....|.....|
```

Template

Grid Data Record [GRIDREC] 51 for Land-Form PROFILE DTMs

Field	Position	Format	Value example	Description
REC_DESC	01:02	A2	51	Grid Data Record identifier.
GRID_ID	03:10	I8	00000001 to 00000501	Unique reference identifying the column.
N_Z_COORD	11:18	I8	00000501	Number of height values (same as {N_ROWS} in [GRIDHREC]).
Z_COORD	*.*	I5	00086	Height value.
CONT_MARK	*.*	I1	1 or 0	Continuation record follows or no continuation record.
EOR	*.*	A1	%	Record terminator.

Record example:

```
5100000000100000501-0023-0023-0023-0023-0023-0023-0023-0023-0023-0023-0023-00231%
00-0023-0023-0023-0023-0023-0023-0023-0023-0023-0023-0023-0023-00231%
000001100004-0003-0010-0016-0023-0028-0028-0028-0028-0028-0028-0028-00281%
```

....1....2....3....4....5....6....7....8
123456789012345678901234567890123456789012345678901234567890123456789012345678901234567890								
....

Template

Volume Terminator Record [VOLTERM] 99 for Land-Form PROFILE DTMs

Field	Position	Format	Value example	Description
REC_DESC	01:02	A2	99	Volume Terminator Record identifier.
FREE_TEXT	03:*	A*		See NOTE below.
CONT_VOL	*+1:#+1	I1	0 or 1	No continuation volume or continuation volume follows.
EOR	*+2:#+2	A1	%	Record terminator.

NOTES:

If there are further volume(s) to follow then the FREE_TEXT field comprises the following message:

```
`End Of Volume (nn) Transfer Set Continues On Volume (nn+1)'
```

If there are no further volumes then the FREE_TEXT field will read:

```
`End Of Transfer Set'
```

* = variable integer.

Record examples:

```
99End Of Volume 01 Transfer Set Continues On Volume 021%
```

....1....2....3....4....5....6....7....8
123456789012345678901234567890123456789012345678901234567890123456789012345678901234567890								
....

Template

```
99End Of Transfer Set0%
```

....1....2....3....4....5....6....7....8
123456789012345678901234567890123456789012345678901234567890123456789012345678901234567890								
....

Template

Chapter 3 DXF explained

An overview of Land-Form PROFILE

This chapter describes the representation of Land-Form PROFILE in Ordnance Survey's implementation of DXF, including the DXF group and section structure.

It is assumed that the reader of this guide is familiar with the sections about DXF in the appropriate AutoCAD manual, published by Autodesk Ltd, Cross Lane, GUILDFORD, GU1 1UJ, or an equivalent document published by the reader's software supplier if a CAD package other than AutoCAD is to be used.

Structure of Land-Form PROFILE contours

Land-Form PROFILE contour data has a vector point and line structure; within this structure a feature may be a point or a line. Each feature is free-standing: its topological relationship to any other feature is not expressed in the data.

Features are classified by type and each type is placed in a separate DXF layer.

Line features

A feature is a subjective entity; that is, so long as the constituent lines are of the same description (layer), a feature need not fully describe a logical piece of detail. The extent of a feature is determined by digitising conventions and will not always coincide with the topology.

Each line feature is composed of a string of coordinate pairs (or triples) implicitly joined by straight lines. Vector (point and line) data was originally intended for map production.

Structure of Land-Form PROFILE DTMs

The DTM tiles in DXF consist of a series of heightened points arranged on a 10 m grid comprising 501 points by 501 points.

Each of these points have full three-dimensional coordinates.

The first point is positioned on the south-west corner of the tile, with further points at 10 m intervals northwards to the northern edge of the tile, creating a column of 501 points. The next column will start on the southern edge of the tile 10 m east of the origin, again progressing in 10 m intervals to the north edge of the tile.

This pattern is repeated until the final point, which falls on the north-east corner of the tile. Therefore, there are a total of 251 001 points on each tile.

Land-Form PROFILE DXF layers

Generalised feature record representation

The following is a simplified generalisation of the way individual feature records are organised in Ordnance Survey's implementation of DXF:

Point	LAYER	Coordinate triple		
2-D polyline	LAYER	Coordinate triple	Coordinate triple	Height

A 2-D polyline in DXF actually has three dimensions, that is x, y and z coordinates at each vertex on the line. It is known as a 2-D polyline because its height (z) value does not vary along its length.

Land-Form PROFILE footnotes

Each map data file contains a set of map footnotes. Layer G8020571 for contours is as follows:

This includes data on the source and history of the geometric data (the features) contained in the map data file. The following items are all included in the footnotes and are available for display and plotting from a Land-Form PROFILE map file:

- Note 1:** Top margin centrally aligned, 175 ground metres.
Ordnance Survey®
- Note 2:** Top margin centrally aligned, 150 ground metres.
Land-Form PROFILE™ data
- Note 3:** Lower left margin, 50 ground metres.
Translation date dd Mmmmmmmmm CCYY
- Note 4:** Lower left margin, 50 ground metres.
Tile reference number __ __ __
- Note 5:** Lower left margin, 50 ground metres.
Reproduced from Ordnance Survey Land-Form PROFILE™ data with the permission of the controller of Her Majesty's Stationary Office.
© Crown Copyright CCYY
- Note 6:** Lower right margin, 50 ground metres.
The derived scale of the product is dependent upon the source data.
- Note 7:** Lower right margin, 50 ground metres.
Height given in metres above Newlyn Datum.
- Note 8:** Lower right margin, 50 ground metres.
Date of last amendment dd Mmmmmmmmm CCYY
- Note 9:** Lower right margin, 50 ground metres.
Product Specification __ __ __
- Note 10:** Lower right margin, 50 ground metres.
Location of change xxxxxxxx
- Note 11:** Lower right margin, 50 ground metres.
Surveyed units of change xxx
Layer G8090571 for DTMs is as follows:
- Note 1:** Top margin centrally aligned, 175 ground metres.
Ordnance Survey®
- Note 2:** Top margin centrally aligned, 150 ground metres.
Land-Form PROFILE™ data
- Note 3:** Lower left margin, 50 ground metres.
Translation date dd Mmmmmmmmm CCYY
- Note 4:** Lower left margin, 50 ground metres.
Tile reference number __ __ __
- Note 5:** Lower left margin, 50 ground metres.
Reproduced from Ordnance Survey Land-Form PROFILE™ data with the permission of the controller of Her Majesty's Stationary Office.
© Crown Copyright CCYY

- Note 6:** Lower right margin, 50 ground metres.
The derived scale of the product is dependent upon the source data.
- Note 7:** Lower right margin, 50 ground metres.
Height given in metres above Newlyn Datum.
- Note 8:** Lower right margin, 50 ground metres.
Location of change xxxxxxxx
- Note 9:** Lower right margin, 50 ground metres.
Surveyed units of change xxx
- Note 10:** Lower right margin, 50 ground metres.
Date of last amendment dd Mmmmmmmmm CCYY
- Note 11:** Lower right margin, 50 ground metres.
Product Specification _ _ _ _

Figure 4: Layout of notes

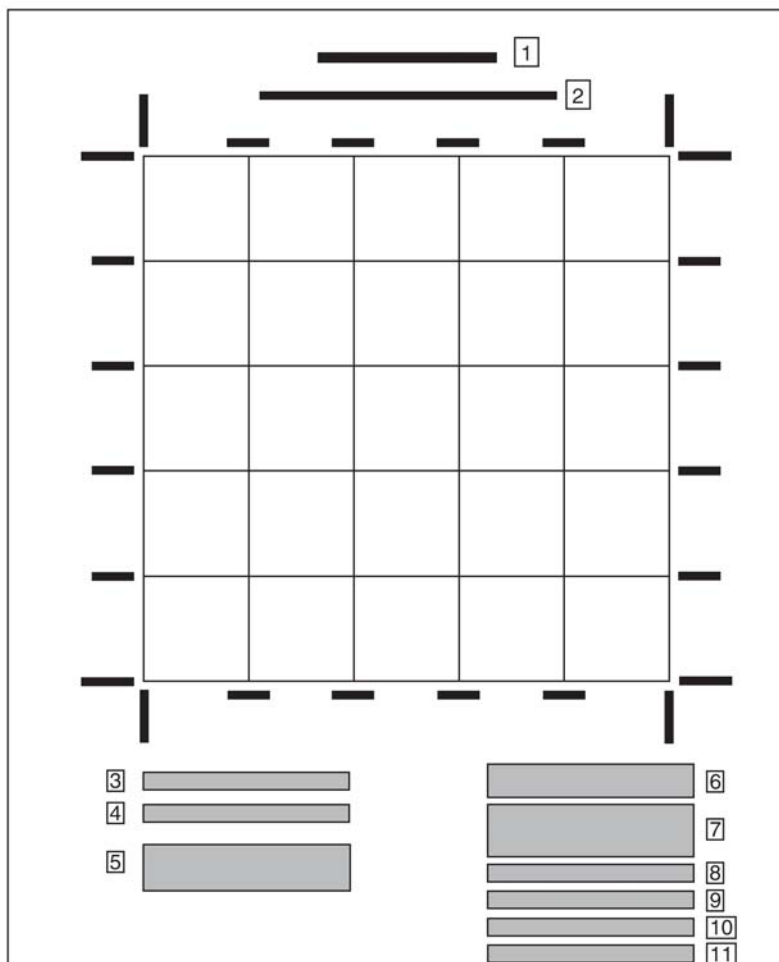

Layers lists

The following are lists of layers that may be included in a Land-Form PROFILE DXF data file and are shown in numerical order of feature code.

Land-Form PROFILE DTMs in DXF

Layer name	Description	Linetype	Entity	Colour
G8090030	DTM height data	CONTINUOUS	POINT	WHITE
G8090571	Footnotes and grid values	STANDARD	INSERT	WHITE
G8090572	Grid lines	CONTINUOUS	LINE	WHITE
G8090573	Grid values	CONTINUOUS	LINE/TEXT	WHITE
G8090575	Default	CONTINUOUS	POLYLINE	WHITE

Land-Form PROFILE Contours in DXF

Layer name	Description	Linetype	Entity	Colour	Block
G8020027	Spot heights	CONTINUOUS	INSERT	WHITE	SPOTH
G8020071	High water mark	CONTINUOUS	POLYLINE	BROWN	
G8020072	Low water mark	CONTINUOUS	POLYLINE	CYAN	
G8020075	Contours	CONTINUOUS	POLYLINE	WHITE	
G8020571	Footnotes and grid values	CONTINUOUS	INSERT	WHITE	
G8020572	Grid lines	CONTINUOUS	LINE	WHITE	
G8020573	Grid values	CONTINUOUS	TEXT	WHITE	
G8020575	Default	CONTINUOUS	POLYLINE	WHITE	
G8021361	Index contours	CONTINUOUS	POLYLINE	WHITE	
G8021372	Air heights	CONTINUOUS	INSERT	YELLOW	SPOTH

Overview of DXF file structure for Land-Form PROFILE

The DXF file is structured into a number of sections, each of which holds specific information relating to the drawing. The overall organisation of the file is as follows:

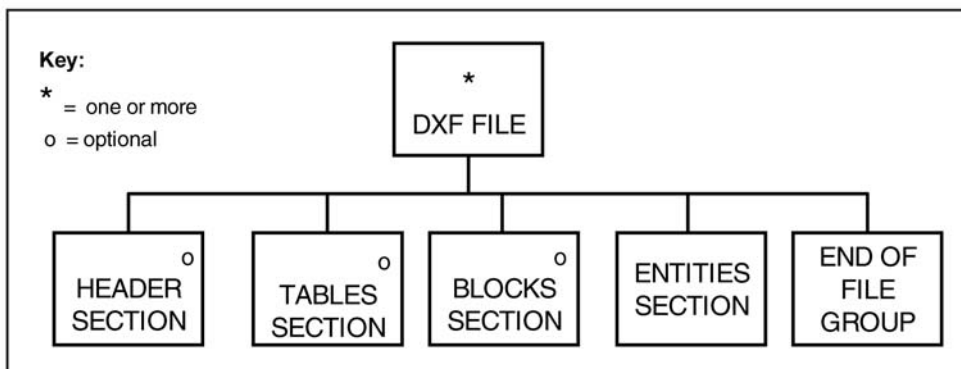

Chapter 4 DXF file structure for Land-Form PROFILE

General

The following paragraphs contain examples of DXF records with explanatory notes alongside.

Data structure

Header section

A DXF file will commence with a header section which will contain general information about the drawing. Each of the groups consists of a variable name and an associated value or values.

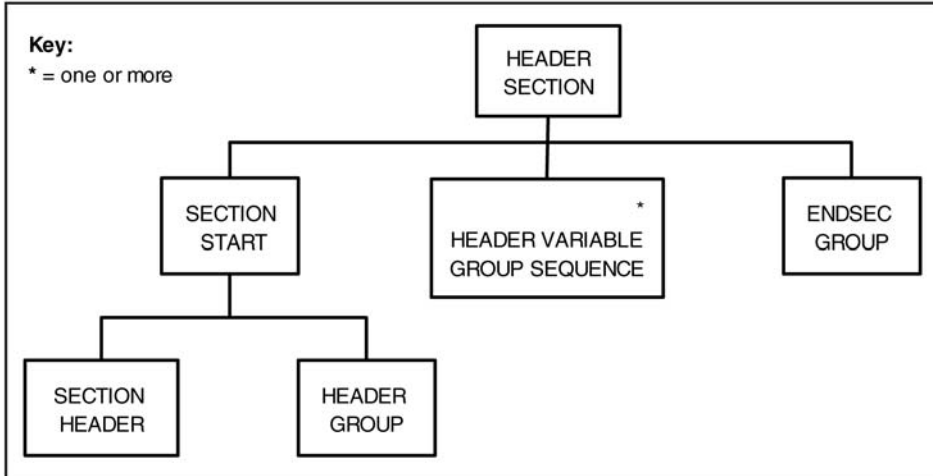

Thus:

0	
SECTION	
2	
HEADER	
9	
\$ACADVER	AutoCAD drawing database version number.
1	
AC1009	This indicates release 11 or 12.
9	
\$EXTMIN	X and Y drawing extents, lower left corner.
10	
nnnnnnn . nn	Minimum eastings (NG coordinates).
20	
nnnnnnn . nn	Minimum northings (NG coordinates).
9	
\$EXTMAX	X and Y drawing extents, upper right corner.
10	
nnnnnnn . nn	Maximum eastings (NG coordinates).
20	
nnnnnnn . nn	Maximum northings,(NG coordinates).
9	

\$LIMMIN	X and Y drawing limits, lower left corner.
10	
nnnnnn . n	X drawing limit, lower left corner (in the AutoCAD world coordinate system (WCS)).
20	
nnnnnn . n	Y drawing limit, lower left corner (in WCS).
9	
\$LIMMAX	X and Y drawing limits, upper right corner.
10	
nnnnnn . n	X drawing limit, upper right corner (in WCS).
20	
nnnnnn . n	Y drawing limit, upper right corner (in WCS).
9	
\$LTSCALE	Global linetype scale.
40	
1 . 0	
9	
\$ATTMODE	Attribute visibility.
70	
1	This sets attributes to on when the tile is open.
9	
\$FILLMODE	Fill mode on if non-zero.
70	
1	
9	
\$TEXTSIZE	Default text height.
40	
1 . 0	
9	
\$TEXTSTYLE	Current text style name.
7	
STANDARD	
9	
\$CELTYPE	Entity linetype name.
6	
BYLAYER	
9	
\$CECOLOR	Entity colour number.
62	
256	Indicates colour ID BYLAYER.
9	
\$LUNITS	Units format for coordinates and distances.
70	
2	
9	

\$LUPREC Units precision for coordinates and distances.
70
 1
9

\$AUPREC Units precision for angles.
70
 1
9

\$ANGBASE Angle zero direction.
50
 0.0
9

\$ANGDIR Angle rotation.
70
 0 1 = clockwise angles, 0 = anticlockwise angles.
9

\$PDMODE Point display mode.
70
 1
9

\$PDSIZE Point display size.
40
 0.0
0

ENDSEC End of section.

Tables section

The tables section will follow the header section and contains definitions of named items. Within Land-Form PROFILE, it will normally contain three tables:

- the **linetype table** which will contain the definition for the solid line linetype;
- the **layer table** which will contain the layer definitions (and their colours and linetypes) for the layers within the drawing; and
- the **style table** which may define the files from which to access symbols and text fonts.

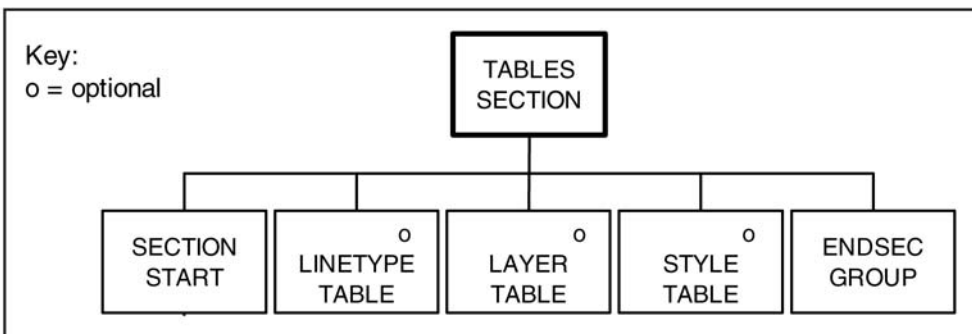

DXF example

Notes

0

SECTION

Section start.

2

TABLES

Tables section.

|
|

<<table definitions go here>>
of these.

LINETYPE, LAYER and STYLE tables. The following pages give examples

|
|

0

ENDSEC

End of tables section.

Linetype table

The linetype table is part of the tables section and defines the styles of lines used in the map.

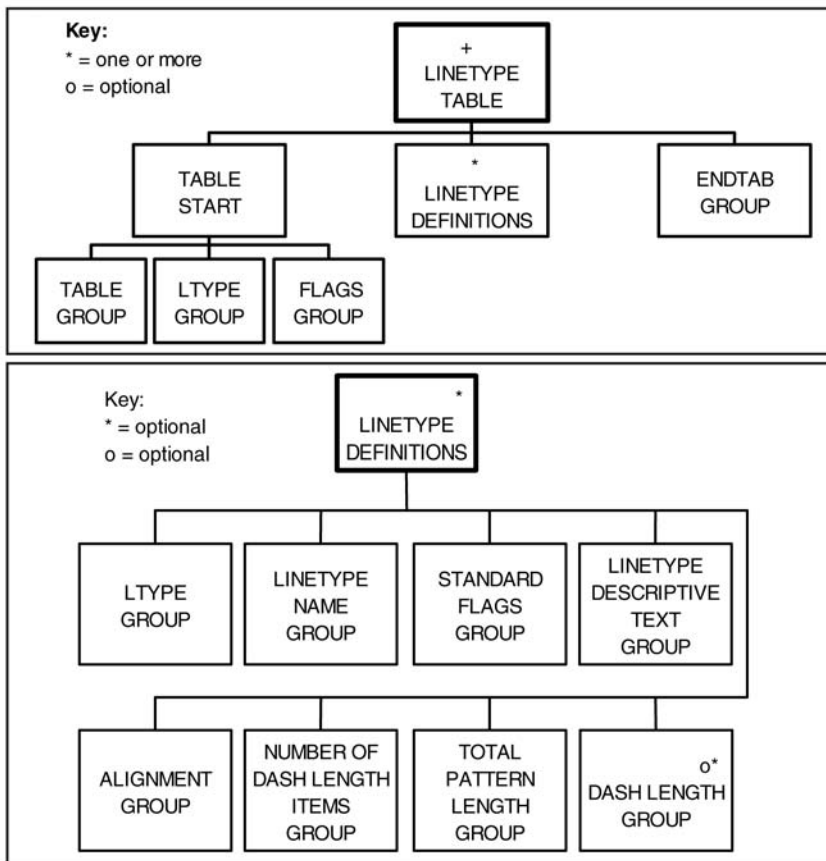

DXF example	Notes
0	
TABLE	Table start.
2	
LTYPE	Linetype table.
70	
1	Flags group.
0	
LTYPE	Linetype definition.
2	
CONTINUOUS	Name of linetype.
70	
64	Flags group.
3	
solid line	Linetype description.
72	
65	Alignment.
73	
0	Number of dash length items.
40	
0.0	Total pattern length.
0	
ENDTAB	End of linetype table.

Layer table

The layer table is part of the tables section and defines the layers used in the map.

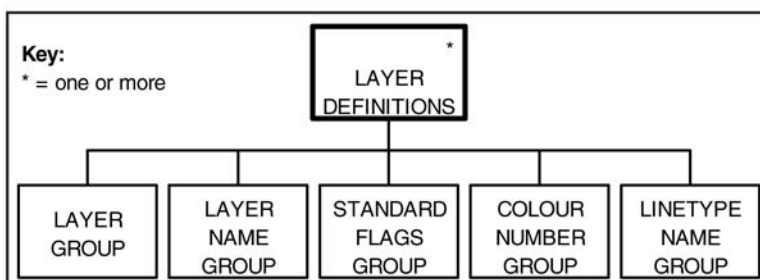
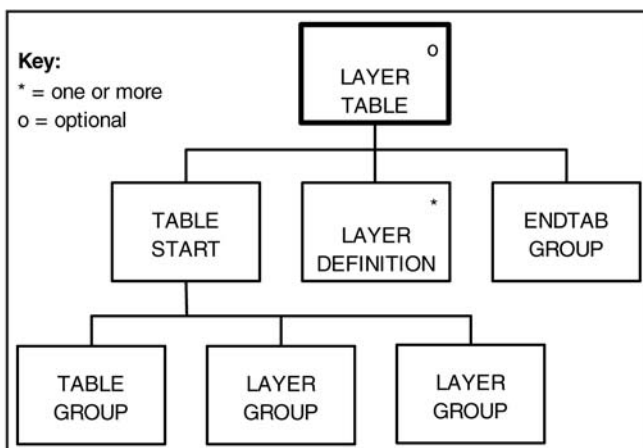

DXF example	Notes
0	
TABLE	Start of table.
2	
LAYER	Layer table (defines layers).
70	
7	Flags group.
0	
LAYER	Start of layer definition.
2	
G8020072	Layer name.
70	
0	Flags group.
62	
0	Colour group.
6	
CONTINUOUS	Linetype group.
0	
LAYER	Start of next layer definition.
0	
ENDTAB	End of layer table.

Style table

The style table is part of the tables section and defines the files from which to access symbols and text fonts.

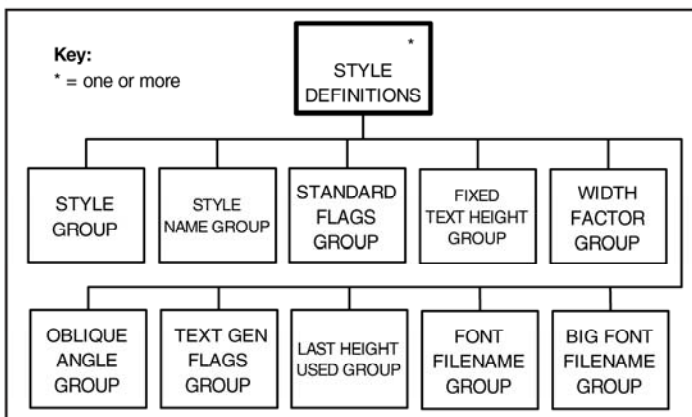
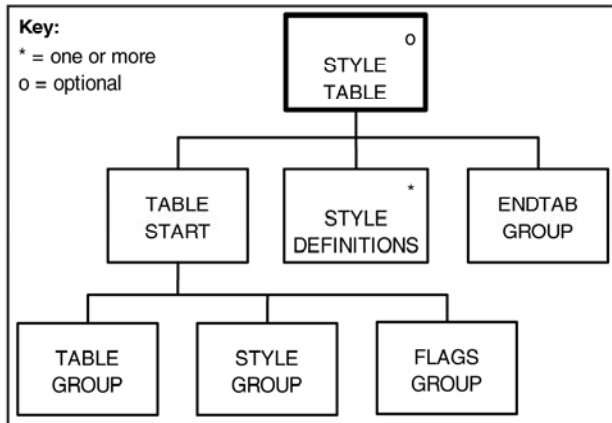

DXF example	Notes
0	
TABLE	Start of table.
2	
STYLE	Style table (defines symbols and text fonts).
70	
5	Standard flags group.
0	
STYLE	Start of style definition.
2	
STANDARD	Style name group.
70	
64	Standard flags group.
40	
0.0	Fixed text height group.
41	
1.0	Width factor group.
50	
0.0	Oblique angle group.
71	
0	Text gen flags group.
42	
1.0	Last height used group.
3	
SIMPLEX.SHX	Font filename group.
4	
	Big font filename group (no value is used).
0	
STYLE	Next style table.
2	
MONOTEXT	
70	
0	
40	
0.0	
41	
1.0	
50	
0.0	
71	
0	
42	
1.0	
3	
MONOTXT.SHX	
4	

```

0
STYLE
2
MONOTXT
70
    0
40
0.0
41
1.0
50
0.0
71
    0
42
1.0
3
MONOTXT . SHX
4

0
ENDTAB

```

Blocks section

The blocks section defines the symbols (or blocks) which may appear in the drawing. These can be made up from any number of entities such as polylines.

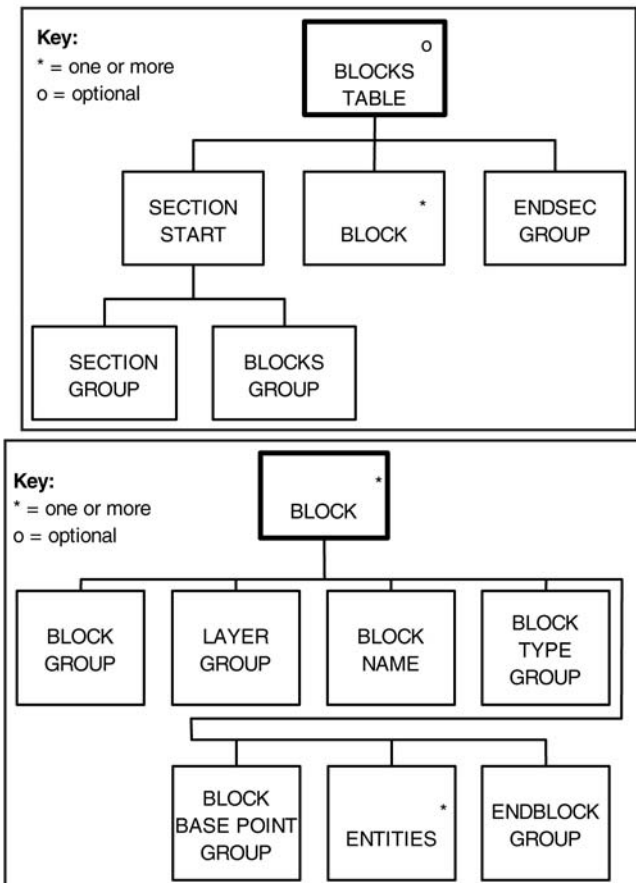

DXF example	Notes
0	
SECTION	Start of section.
2	
BLOCKS	Blocks section (defines symbols).
0	
BLOCK	Start of block.
8	
0	Layer group.
2	
CROSS	Block name.
70	
64	Block type flag.
10	
0.0	X group.
20	
0.0	Y group.
0	
POLYLINE	Polyline entity to define block.
8	May consist of any number and/or type of entities.
0	
0	
SEQEND	End of polyline.
8	
0	
0	
ENDBLK	End of block.
8	
0	
0	
BLOCK	Start of next block.
0	
ENDBLK	End of block.
8	
0	
0	
ENDSEC	End of section.

Entities section

The entities section will contain DXF entities for:

- Ordnance Survey map footnotes data (INSERT entities);
- Grid and neatline (TEXT and LINE entities); and
- Ordnance Survey map features (TEXT, POLYLINE and INSERT entities).

The structure of each different entity is as follows:

- INSERT entities – these consist of:
 - INSERT entity type group (Group number: 0)
 - Layer name group (8)
 - Block name group (2)
 - X coordinate group (10)
 - Y coordinate group (20)
 - Z coordinate group (30) [optional]
 - X scale factor (41) [optional]
 - Y scale factor (42) [optional]
 - Z scale factor (43) [optional]
 - Rotation angle (50) [optional if 0]
- LINE entities – these consist of:
 - LINE entity type group (0)
 - Layer name group (8)
 - Start X coordinate group (10)
 - Start Y coordinate group (20)
 - Start Z coordinate group (30) [optional]
 - End X coordinate group (11)
 - End Y coordinate group (21)
 - End Z coordinate group (31) [optional]
- POLYLINE entities – these consist of:
 - POLYLINE entity type group (0)
 - Layer name group (8)
 - Vertices follow flag group (66)
 - Polyline elevation (30) [optional]
 - Polyline flag group (70) [optional]
 - A number of VERTEX entities [shown below]
 - SEQEND group (0)
- VERTEX entities – these consist of:
 - VERTEX entity type group (0)
 - Layer name group (8)
 - X elevation (10) [set too]
 - Y elevation (20) [set too]
 - Z elevation (30)
 - Vertex flag group (70) [optional]

- TEXT entities – these consist of:
 - TEXT entity type group (0)
 - Layer name group (8)
 - X coordinate group (10)
 - Y coordinate group (20)
 - Z coordinate group (30) [optional]
 - Text height group (40)
 - Text value group (1)
 - Rotation angle group (50) [optional if 0]
 - Text style name group (7) [optional]
 - Justify type group (72) [optional if 0]
 - Justify type group (73) [optional if 0]

Level 2

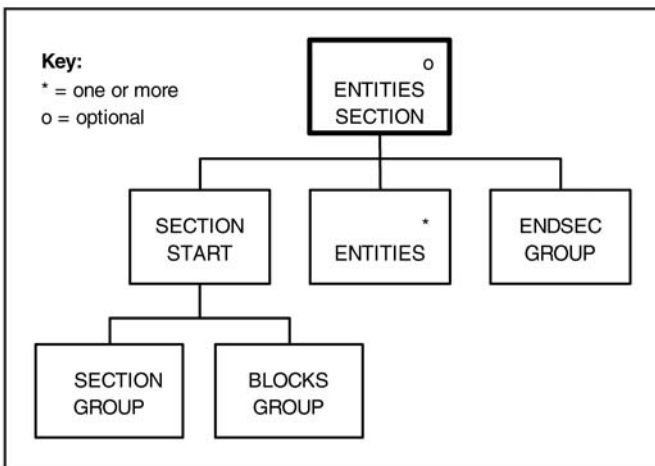

Level 3

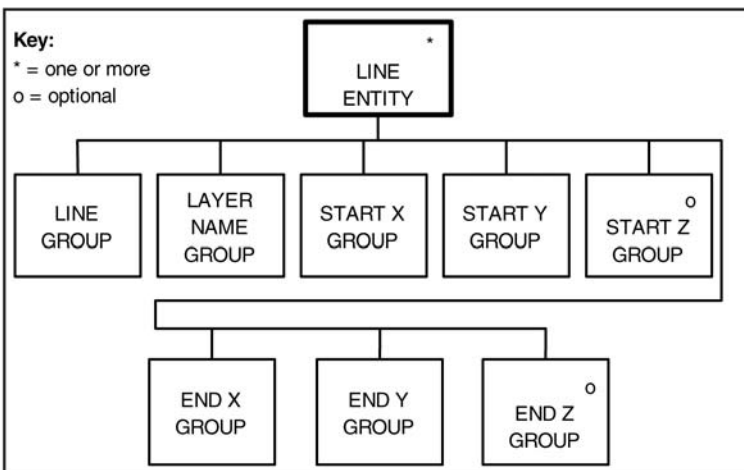

Level 4

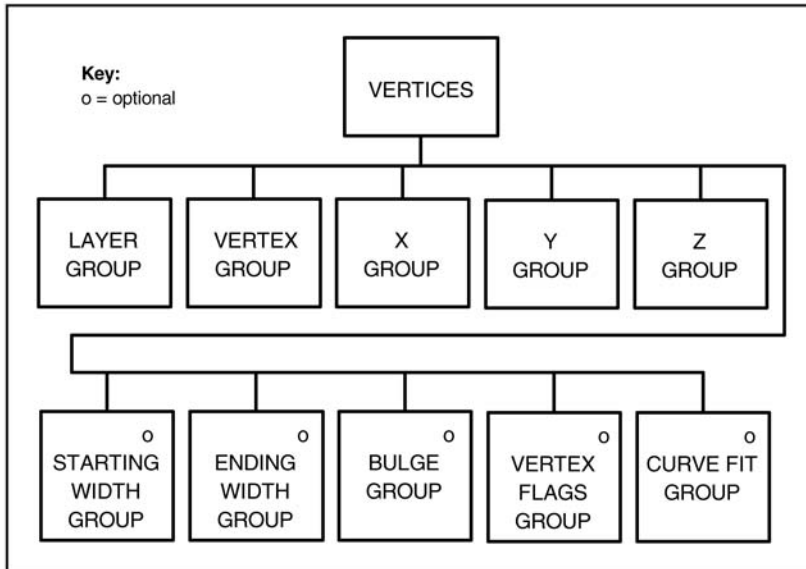

End of file group

This group will end with DXF EOF (end of file) group.

Annexe A Glossary

accuracy

The closeness of the results of observations, computations or estimates to the true values or the values accepted as being true. Accuracy relates to the exactness of the result and is a measure of the exactness of the operation by which the result is obtained.

air height

A coordinated control point, which can be identified on the ground and also in aerial photos, that is used to provide vertical control.

ASCII

American Standard Code for Information Interchange – a standard binary coding system used to represent characters within a computer.

attribute

An attribute is a property of an entity, usually used to refer to a non-spatial qualification of a spatially referenced entity. For example, a descriptive code indicating what an entity represents or how it should be portrayed.

basic scale

The scale at which the survey is undertaken. For Ordnance Survey mapping, three scales are used – 1:1250, 1:2500 and 1:10 000. Any area is only maintained at one basic scale.

basic scale file or unit tile (sheet)

A grouping of topographic information relating to a specific spatial extent in the form of a map, either held as a data file or realised on paper.

basic scale map

The largest scale of map published for a particular area of the UK. This may be 1:1250 scale for urban areas, 1:2500 scale for rural areas or 1:10 000 scale for mountain and moorland areas.

bench mark (BM)

A survey point, on a fixed object, the height of which has been measured in relation to Ordnance Survey Datum.

bit

An unit of information, the word a blend of binary and digit.

breakline

A line indicating discontinuity in a terrain surface, that is, an abrupt change in gradient.

byte

A unit of computer storage of binary data usually comprising 8 bits, equivalent to a character. Hence [megabyte](#) (Mb) and [gigabyte](#) (Gb).

cartography

The organisation and communication of geographically related information in either graphic or digital form. It can include all stages from data acquisition to presentation and use.

character

A distinctive mark; an inscribed letter; one of a set of writing symbols.

character set

A one-dimensional array of characters held either in memory or in another storage medium.

character string

A set of letters, numerals, punctuation marks, mathematical and other symbols. Standard sets have been drawn up such as ANSI, ISO and others.

compact disc-read only memory (CD-ROM)

A data storage medium. A 12 cm disc similar to an audio CD.

contiguous

Literally adjacent, touching. In the context of digital mapping, the word has a special meaning and implies a connected entity.

continuation mark

A [logical record](#) may contain more data than can be held in a single [physical record](#). The physical record contains a continuation mark – the penultimate character of the record, in NTF – to indicate whether more data is to be found in a continuation record.

continuation record

A specific NTF term. A continuation record is used where space does not allow one logical record to be contained wholly within one [physical record](#).

contour

A line connecting points of equal elevation.

coordinate pair

A coordinate pair is an [easting](#) and a [northing](#).

coordinates

Pairs of numbers expressing horizontal distances along orthogonal axes. Alternatively, triplets of numbers measuring horizontal and vertical distances. Row and column numbers of pixels from raw imagery are not considered coordinates for the purpose of the standard.

copyright

Copyright is a legal property right which enables the creator of an original work to protect it from unauthorised use. Through the *Copyright, Designs and Patents Act 1988*, Crown copyright continues to subsist in all Ordnance Survey products until the end of the period of 50 years from the end of the year in which they were published and, in the case of data, from the end of the year in which it was extracted from the Ordnance Survey database. Crown copyright is vested in The Controller of Her Majesty's Stationery Office, who has delegated powers to the Director General, Ordnance Survey for the administration of copyright in publications and data, including the determination of the rules and terms under which permission for their reproduction is given.

currency

An expression of how up-to-date the data is.

DAT

Digital audio tape.

data

A representation of facts, concepts or instructions in a formalised manner suitable for communication, interpretation or processing.

database

An organised, integrated collection of data stored so as to be capable of use in relevant applications, with the data being accessed by different logical paths. Theoretically it is application-independent, but in reality it is rarely so.

data capture

The encoding of data. In the context of digital mapping this includes map [digitising](#), direct recording by electronic survey instruments, and the encoding of text and attributes by whatever means.

data format

A specification that defines the order in which data is stored or a description of the way data is held in a file or record.

data model

An abstraction of the real world which incorporates only those properties thought to be relevant to the application or applications at hand. A data model would normally define specific groups of entities and their [attributes](#), and the relationship between these entities. A data model is independent of a computer system and its associated data structures. A map is one example of an analogue data model.

data point

A coordinate pair or triplet which defines the position of a point feature, or one of a series of coordinate pairs or triplets which defines a line feature.

dataset

An Ordnance Survey term for a named collection of logically related **features** arranged in a prescribed manner. For example, all water features. A dataset has more internal structure than a layer and is related to another dataset only by position.

Data as supplied in a particular format to customers – internal or external to Ordnance Survey.

A set of objects that have been captured to a particular data specification.

data structure

The defined logical arrangement of data as used by a system for data management; a representation of a data model in computer form.

density

A measure of the number of units of data held on a stated length of storage surface. For example, some magnetic tapes may be recorded at a density of 1 600 bits per inch (bpi). Often referred to as packing density.

digital

Data which are expressed as numbers (digits) in computer-readable form are said to be digital.

digital elevation model (DEM)

A generic term describing a digital representation of a **topographic** surface. The surface elevation values can be represented in various forms, for example, by contours, spot heights or breaklines, a regular grid or triangulated irregular network (TIN) and so on. A DEM may also include surface features such as buildings, vegetation and so on.

digital map

A term used by Ordnance Survey to describe a particular tile of digital map data.

digital map data

The digital data required to represent a map. The data includes not only map detail but also feature header data, map header data and management data.

digital map file

The digital map data comprising a map sheet unit.

digital map unit (DMU)

Synonymous with digital map file.

digital terrain image (DTI)

A two-dimensional model representing the **topographic** surface. Surfaces between contours, or sets of contours, are coloured or shaded as required.

digital terrain model (DTM)

A DEM primarily defining the ground surface. This will normally exclude ground surface features such as buildings, woodland, and so on. Note: this is a well established term which preceded DEM as a generic description.

digitising

The process of converting analogue maps and other sources to a computer-readable form. This may be point digitising – points are only recorded when a button is pressed on a cursor, or stream digitising – points are recorded automatically, at preset intervals of either distance or time.

dots per inch (dpi)

The resolution, or fineness, of a raster image.

DXF (Data Exchange Format)

A proprietary data format, devised by Autodesk[®], by which digital drawings may be transferred between users of CAD (computer-aided design) systems. DXF has become an industry standard data format and is used for the transfer of Ordnance Survey digital map data.

eastings

See [rectangular coordinates](#).

edge

An edge is a curve joining two possibly identical nodes without intersecting an edge – including itself. Any sequence of edges either bounds a face and/or represents a line feature.

edgematch

The process of ensuring that data along the adjacent edges of map sheets, or some other unit of storage, matches in both positional and [attribute](#) terms.

edit

The process of validating and correcting errors in [digital map data](#).

EBCDIC (extended binary coded decimal interchange code)

An 8-bit character encoding scheme.

feature

An item of detail within a map which can be either a point or symbol, a line or text; a geographical entity such as a building or stream, either taken from a map or surveyed directly from the real world.

feature classification record

A specific, named NTF record which lists the [feature codes](#) in use in the current [database](#).

feature code (FC)

An alphanumeric code describing or classifying a [feature](#) – used in [digital map data](#) as an [attribute](#) code to describe each feature in terms of the object surveyed, its representation on the map, or both.

feature identifier

A unique code to identify an individual [feature](#). See also feature serial number.

feature serial number (FSN)

A number used as a feature identifier usually allocated on a sequential basis. For example, the order in which [features](#) are digitised.

field

A specified part of a [record](#) containing a unit of data, such as the date of [digitising](#). The unit of data may be a data element or a data item. In NTF a field is a subdivision of a [physical record](#). Every field has a name and a pre-defined interpretation.

floppy disk

A magnetic medium, generally used in micro-computers (PCs) – available in 3½ inch and 5¼ inch sizes.

format

The specified arrangement of data. For example, the layout of a printed document, the arrangement of the parts of a computer instruction, the arrangement of data in a [record](#).

formline

A supplementary contour – not corresponding to the normal contour vertical interval – estimated or interpolated from surrounding contours, used in areas where there is insufficient height information to control the creation of a grid DEM.

form spot

A supplementary spot height, estimated or interpolated from surrounding heights, in areas where few contours or other height information exist, for example, low-lying parts of East Anglia. Used to control the creation of [DEMs](#).

generalisation

The process of abstraction from the real world – through selection, aggregation, simplification and symbolisation – for the purpose of representation in spatial data.

geographical information system (GIS)

A system for capturing, storing, checking, integrating, analysing and displaying data that is spatially referenced to the earth. This is normally considered to involve a spatially referenced computer database and appropriate applications software.

geometric data

Data about position within an absolute or relative coordinate system.

geometric structure

The relationships, implied or explicit, between the points and lines forming a dataset and representing the real world.

gigabyte (Gb)

1 073 741 824 bytes, a measure of data storage capacity.

grid

The planimetric frame of reference, for example, the National Grid.

hard copy

A print, or plot of output data, on paper or some other tangible medium.

header

See [map header](#).

information

Intelligence resulting from the assembly, analysis or summary of data into a meaningful form.

kilobyte (kb)

1 024 bytes; a measure of data storage capacity.

line

A series of connected coordinated points forming a simple feature with homogeneous attribution.

line feature

The spatial abstraction of an object in one dimension. Lines may intersect with other lines. They are defined as a series of two or more coordinates and may be curved or straight. Curved lines consist of a series of very short straight line segments. Lines may be concurrent with other lines under certain conditions. As an object abstraction a line has no width.

line segment

A vector connecting two coordinated points.

logical record

A logical record contains all the information relating to a data entity, for example, a feature record. A logical record may comprise one or more physical records.

map

An holistic representation and intellectual abstraction of geographical reality, intended to be communicated for a purpose or purposes, transforming relevant geographical data into an end-product which is visual, digital or tactile.

map header

Data at the start of the [digital map file](#) describing that data. It may contain information on the source and history of the [geometric data](#) within the map and the coordinate system in use.

map scale

The ratio between the extent of a feature on the map and its extent on the ground, normally expressed as a representative fraction, for example, 1:1250 scale, 1:50 000 scale.

mean high water/springs (MHW or MHWS)

Depiction of the encroachment of land by tidal waters at mean highest levels – spring tides in Scotland.

mean low water/springs (MLW or MLWS)

Depiction of limits of tidal waters at mean lowest ebb – spring tides in Scotland.

megabyte (Mb)

1 048 576 bytes, a measure of data storage capacity.

model

See [data model](#).

National Grid (NG)

A unique referencing system which can be applied to all Ordnance Survey maps of Great Britain (GB) at all scales. It is based on 100 km squares covering the whole of GB based on a Transverse Mercator Projection. It is used by Ordnance Survey on all post-war mapping to provide an unambiguous spatial reference in GB for any place or entity whatever the map scale. The National grid is defined by the OSGB36[®] spheroid.

NTF (National Transfer Format)

A format designed in 1988 specifically for the transfer of spatial information; it is administered by the British Standards Institution (BSI). It is now the standard transfer format for Ordnance Survey digital map data. Its present version (2.0) conforms to BS 7567.

normal tidal limit (NTL)

The point at which the level of a river ceases to be affected by the tidal flow. This point may be an artificial barrier such as a lock or weir.

northings

See [rectangular coordinates](#).

photogrammetry

The science, art and technology of obtaining reliable measurements and maps from aerial photographs.

physical record

A physical record may be fixed length – in which case it contains 80 characters, or variable length – which contains up to 80 characters. See also [logical record](#).

point

A zero-dimensional spatial abstraction of an object represented as a coordinate pair.

point feature

A zero-dimensional spatial abstraction of an object with its position defined by a coordinate pair.

point and line data structure

A form of [vector data](#) structure designed for map production in which all map features are designated as points or lines or text. Point and line data do not carry the topological relationships between features.

positional accuracy

The degree to which the coordinates define a point's true position in the world, directly related to the spheroid and/or projection on which the coordinate system is based.

precision

The exactness with which a value is expressed, whether the value be right or wrong.

record

A set of related data fields grouped for processing.

rectangular coordinates

Also known as X-Y coordinates and as eastings and northings. These are two-dimensional coordinates which measure the position of any point relative to an arbitrary origin on a plane surface, for example, a map projection, a digitising table, a VDU screen.

representation

Depiction or description of an object using symbology.

resolution

A measure of the ability to detect quantities. High resolution implies a high degree of discrimination but has no implication as to [accuracy](#). For example, in a collection of data in which the coordinates are rounded to the nearest metre, resolution will be 1 metre, but the accuracy may be ± 5 metres or worse.

source scale

The scale of the source information from which the map was digitised, that is, the scale of survey for a basic scale map, or the scale of the source map for a derived map.

spatial data

Data which includes a reference to a two- or three-dimensional position in space as one of its attributes. It is used as a synonym for [geometric data](#).

spot height

A point on the earth's surface for which the height, above a reference datum, is known and which has been fixed by observation.

structure

See [data structure](#).

surveying

The determination of the absolute and relative positions of points, on or near the earth's surface, by means of measurement in the three elements of space – distance, direction and elevation – and, hence, their subsequent representation onto a plane surface, exhibiting them in their correct horizontal and vertical relationships.

terminator

A character, or character string, or field or record used to signal the end of a record or section or volume or database.

tile

Broadly synonymous with [digital map file](#), it implies evenly sized map sheet units.

topography

The study of the physical features of the earth. A topographic map's principal purpose is to portray and identify the features of the earth.

topology

The study of the properties of a geometric figure which are not dependent on position, such as connectivity, relationships between lines, nodes and polygons.

transfer format

The [format](#) used to transfer data consistently between computer systems. In general usage this can refer not only to the organisation of data, but also to the associated information, such as attribute codes, which are required in order to successfully complete the transfer.

transfer set

A specific [NTF](#) term for the data, together with its supporting information, which the customer receives.

vector

A straight line joining two data points.

vector data

Positional data in the form of coordinates of the ends of line segments, points, text positions, and so on.

volume

A physical unit of the transfer medium, that is, a single disk, a single cartridge or a single tape.