



Meridian[®] 2

User guide

Preface

This user guide contains all the information you need to make effective use of Meridian[®] 2. It is designed to help you understand the information contained in the data, as well as providing detailed technical information and the data format specification.

This user guide has been checked and validated before issue and every endeavour made to ensure that the contents are accurate. If you find an error or omission, or otherwise wish to make a suggestion as to how this user guide can be improved, please contact us at the address shown under Contact details.

Contact details

Customer Contact Centre will be pleased to deal with your enquiries:

Phone: 023 8030 5030
Fax: 023 8079 2615
Email: customerservices@ordnancesurvey.co.uk.

Welsh Language HelpLine [in Welsh] phone: 08456 05 05 04.

or write to:

Customer Contact Centre
Ordnance Survey
Romsey Road
SOUTHAMPTON
United Kingdom
SO16 4GU

Visit the Ordnance Survey[®] web site at: www.ordnancesurvey.co.uk.

Product performance

If you have any problems with or identify any errors in the data, or this user guide, please complete the *Product and service performance report form* at [appendix C](#) and return it to us.

Liability

Your use of the Meridian 2 product is subject to the terms and conditions of supply and use within the Customer contract held by you or your organisation and those terms and conditions take precedence in the event of any inconsistency between the terms of the Customer contract and this user guide.

Ordnance Survey makes every effort to ensure that data supplied is free from errors and omissions. Your remedies in the event of the data supplied contain any errors and omissions are as set out in the Customer contract. It is however, the customer's responsibility to ensure that data ordered is suitable for the intended purpose.

Delivery of Meridian 2

You are advised to copy the supplied data to a back-up medium.

Data copyright

All Ordnance Survey digital map data are Crown copyright. Full details of the conditions under which our digital map data may be processed and/or manipulated or copied by a customer – whether or not for use on PCs or workstations or for making hard copies – are contained in Ordnance Survey leaflet: *Copyright 1 – Business use of our digital and conventional mapping*. This is available from Copyright Licensing at the address on the previous page. You should check the terms and conditions with us before using the data. It is also the responsibility of the holder of the digital map data to ensure that any plotted or printed output contains the required copyright acknowledgement.

User guide copyright

This document is © Crown copyright 2004. All rights reserved. It is supplied with Meridian 2 to allow you to make effective use of the data. Any part of it may be copied for your own business use. Business use is defined as actions related to business decision making or as part of day-to-day operations associated with the running of your business or organisation. No part of this document may be copied or incorporated in products, services or publications you generate for onward sale or as free promotional or support material without the prior written permission of Ordnance Survey.

Printing this user guide

If you wish to print this user guide, it is suggested that it is bound on the left side.

Trademarks

Ordnance Survey, the OS Symbol, Land-Form PANORAMA, Land-Line, Landranger, Meridian, OSCAR, OSCAR Asset-Manager, OSCAR Route-Manager and Strategi are registered trademarks and Boundary-Line is a trademark of Ordnance Survey, the national mapping agency of Great Britain.

ArcInfo, ArcView and ESRI are registered trademarks of Environmental Systems Research Institute, Inc.

AutoCAD and Autodesk are registered trademarks and DXF is a trademark of Autodesk Inc.

Helvetica and Univers are registered trademarks of Heidelberger Druckmashiner AG.

MapInfo is a registered trademark of MapInfo Corporation.

Contents

| | | |
|------------------|---------------------------------------|-----------|
| Chapter 1 | Introduction..... | 9 |
| | Meridian 2 features..... | 10 |
| | Applications of Meridian 2..... | 10 |
| | What you need to use Meridian 2..... | 12 |
| | Computer hardware..... | 12 |
| | Computer software..... | 12 |
| | Supply..... | 13 |
| | Meridian 2 supply options..... | 13 |
| | Meridian 2 supply formats..... | 14 |
| | Meridian 2 supply media..... | 14 |
| Chapter 2 | Overview of Meridian 2..... | 15 |
| | Data overview..... | 15 |
| | Basic principles..... | 15 |
| | Meridian 2 vector data structure..... | 15 |
| Chapter 3 | Meridian explained..... | 19 |
| | Features..... | 19 |
| | Points and lines..... | 20 |
| | Feature position..... | 24 |
| | Feature attribute data..... | 24 |
| | Feature codes..... | 24 |
| | Names as attributes..... | 26 |
| | Road number (RN) attribute..... | 26 |
| | Trunk road (TR) attribute..... | 26 |
| | Line length (LL) attribute..... | 26 |
| | OSODR attribute..... | 27 |
| | Link level at node..... | 28 |
| | Proper name (PN) attribute..... | 28 |
| | Roundabout (RT) attribute..... | 29 |
| | Junction name (JN) attribute..... | 29 |
| | Settlement name (SN) attribute..... | 30 |
| | Unique identifiers..... | 30 |
| | Feature layer descriptions..... | 32 |
| | 1 Roads..... | 32 |

| | | | |
|------------------|---|--|-----------|
| | 2 | Railways | 32 |
| | 3 | Administrative areas and coastline | 32 |
| | 4 | Developed land use areas | 34 |
| | 5 | Cartographic names | 34 |
| | 6 | Hydrology..... | 35 |
| | 7 | Woodlands | 36 |
| | 8 | Gridded height..... | 37 |
| Chapter 4 | | Quality statement | 38 |
| | | Source of Meridian 2 | 38 |
| | | Currency..... | 39 |
| | | Accuracy and resolution..... | 39 |
| | | Completeness | 40 |
| | | Meridian general specifications | 40 |
| Chapter 5 | | The National Grid | 41 |
| Chapter 6 | | NTF explained | 42 |
| | | An overview of Meridian 2 in NTF | 42 |
| | | Jackson structure | 44 |
| | | Transfer set structure..... | 46 |
| | | Record size..... | 46 |
| | | Record terminator {EOR} | 46 |
| | | Supply of data on formatted media | 47 |
| | | Version management..... | 49 |
| | | General..... | 50 |
| | | Section body | 50 |
| | | Point and line features | 50 |
| | | Name detail..... | 51 |
| | | Node detail | 52 |
| | | Feature information relevant to NTF..... | 53 |
| | | Point features | 53 |
| | | Line features | 53 |
| | | Coordinates | 54 |
| | | Bearings..... | 54 |
| | | Attribute codes | 54 |
| | | Unique identifiers | 56 |
| | | Record IDs..... | 57 |

| | |
|--|-----------|
| Feature layers | 58 |
| Roads..... | 58 |
| Railways..... | 58 |
| Administrative areas and coastline..... | 59 |
| Developed land use areas (DLUA)..... | 59 |
| Cartographic names | 59 |
| Hydrology | 60 |
| Woodlands..... | 60 |
| Height | 60 |
| Chapter 7 Record structures for the transfer of Meridian 2 in NTF..... | 61 |
| NTF Record List..... | 61 |
| Volume Header Record [VOLHDREC] 01 | 62 |
| Database Header Record [DBHREC] 02 | 63 |
| Feature Classification Record [FEATCLASS] 05 | 64 |
| Section Header Record [SECHREC] 07 | 65 |
| Attribute Record [ATTREC] 14 for road links..... | 67 |
| Attribute Record [ATTREC] 14 for road nodes..... | 68 |
| Attribute Record [ATTREC] 14 for administrative area links (<i>county, district, coastline and neat line</i>)..... | 69 |
| Attribute Record [ATTREC] 14 for administrative area points and/or seeds | 70 |
| Attribute Record [ATTREC] 14 for nodes (administrative areas, developed land use area, coastline and railway, hydrology and woodlands) and/or edge nodes (all layers)..... | 71 |
| Attribute Record [ATTREC] 14 for developed land use area links | 71 |
| Attribute Record [ATTREC] 14 for developed land use area points and/or seeds..... | 72 |
| Attribute Record [ATTREC] 14 for cartographic name text | 73 |
| Attribute Record [ATTREC] 14 for railway links | 74 |
| Attribute Record [ATTREC] 14 for railway station nodes..... | 75 |
| Attribute Record [ATTREC] 14 for water feature (river, small)..... | 76 |
| Attribute Record [ATTREC] 14 for water area seeds..... | 77 |
| Attribute Record [ATTREC] 14 for administrative area points and/or seeds | 78 |
| Attribute Record [ATTREC] 14 for gridded height point..... | 79 |
| Point Feature Record [POINTREC] 15..... | 80 |
| Node Record [NODEREC] 16 | 81 |
| Two-dimensional Geometry Record [GEOMETRY1] 21 associated with POINTREC..... | 82 |
| Two-dimensional Geometry Record [GEOMETRY1] 21 associated with LINEREC..... | 83 |
| Line Feature Record [LINEREC] 23..... | 84 |

| | | |
|-------------------|---|------------|
| | Attribute Description Record [ATTDESC] 40 | 85 |
| | Text Record [TEXTREC] 43 | 86 |
| | Text Position Record [TEXTPOS] 44 | 87 |
| | Text Representation Record [TEXTREP] 45 | 88 |
| | Comment Record [COMMENT] 90 | 89 |
| | Volume Terminator Record [VOLTERM] 99 | 90 |
| Chapter 8 | DXF explained..... | 91 |
| | An overview of Meridian 2 in DXF | 92 |
| | DXF | 92 |
| | Structure of Meridian 2 in DXF | 93 |
| | Line features | 93 |
| | Area features | 93 |
| | Name features | 94 |
| | Drawing content and format | 94 |
| | Coordinate system | 94 |
| | Height | 94 |
| | Layer names | 95 |
| | Neatline..... | 95 |
| | Grid | 95 |
| | Grid values..... | 95 |
| | Meridian 2 DXF layers | 96 |
| | DXF footnotes | 98 |
| Chapter 9 | DXF file structure for Meridian 2 | 100 |
| | General..... | 100 |
| | Data structure | 100 |
| | Header | 101 |
| | Tables | 105 |
| | Blocks | 113 |
| | Entities Section | 114 |
| | End of File Group | 122 |
| Chapter 10 | An overview of Meridian 2 in Mid/Mif | 123 |
| | Meridian 2 is available in Mid/Mif | 123 |
| | Structure of Meridian 2 in MapInfo | 124 |
| | Line features | 124 |
| | Area features | 124 |

| | | |
|-------------------|---|------------|
| | Names features..... | 124 |
| | Drawing content and format..... | 125 |
| | Coordinate system..... | 125 |
| | Height..... | 125 |
| | Layer names..... | 125 |
| | Neatline..... | 125 |
| | Grid..... | 126 |
| | Grid values..... | 126 |
| | Important information..... | 126 |
| Chapter 11 | An overview of Meridian 2 in ESRI® shapefile | 127 |
| | Important information..... | 128 |
| | Symbology table..... | 129 |
| Appendix A | Glossary..... | 131 |
| Appendix B | Meridian 2: (MapInfo) Mid/Mif layers | 144 |
| | Important information..... | 144 |
| | Roads – post 1 January 2000–current; FC 3000 full spec of OSCAR Route-Manager, tiles as 10 km by 10 km..... | 145 |
| | Administrative areas and Coastline..... | 145 |
| | Developed land use area (DLUA)..... | 146 |
| | Railways..... | 146 |
| | Cartographic names..... | 146 |
| | Hydrology..... | 147 |
| | Woodlands..... | 147 |
| | Height..... | 148 |
| | Roads – pre 1 January 2000; FC 6000 stripped OSCAR Route-Manager, tiles as 20 km by 20 km..... | 148 |
| Appendix C | Product and service performance report form | 149 |

Chapter 1 Introduction

This user guide is designed to enable users to make effective use of Meridian 2, and contains all the information you will need.

This chapter and [chapter 2](#) provide an introduction to Meridian 2 and illustrate potential applications. [Chapter 3](#) contains details of the components of the data. Please refer to the [glossary](#) if you are unfamiliar with the terms used.

All aspects of Meridian 2 discussed in this user guide relate to Meridian 2 in both BS 7567 (NTF v2.0) and DXF™ (AutoCAD® Release 12) formats. If the two format versions differ in their treatment of a particular aspect, the specific differences will be stated. Icons, as shown below, will be used to denote these differences.



For convenience BS 7567 (NTF v2.0 level 3) is referred to as NTF in this user guide.



Data Exchange Format (DXF) is referred to as DXF in this user guide.

Format information on the Meridian 2 data is contained in [chapter 3](#) and [chapter 8](#).

Ordnance Survey's Meridian 2 provides a comprehensive national database of geographic (spatial) information designed to support a wide range of applications including initial planning and project work at a regional level. Concepts of Meridian 2 are explained fully in [chapter 2](#).

Appropriate software is required to facilitate the customer's intended application.

The database has been derived from Ordnance Survey's existing large- and small-scales digital databases.

Meridian 2 features

- Meridian 2 has feature codes that allow everything in the database to be allocated to a specific category; users can group like-features for search, display and output routines.
- Meridian 2 is defined as a limited link and node structure within each layer. It contains points, lines and nodes. Nodes have pointers to lines that join at the node and, similarly, there are lines that enclose an area containing a point. Some points are not contained within areas enclosed by lines.
- Department for Transport (DfT), road classification numbers are stored in attribute records and are applied to features such as roads. Names applying to administrative areas and developed land use areas are also included in the attribute record of the appropriate point feature
- Annual updating of many of the source databases ensures that high standards of currency and integrity are maintained. The road network in Meridian 2 is a derived and simplified network which has been produced from OSCAR Asset-Manager[®].

Applications of Meridian 2

There are many potential applications for Meridian 2. These include:

- Environmental analysis.
- Flood areas analysis.
- Land management.
- Commercial and/or business site development.
- Retail and/or wholesale trades.
- Distribution networks:
 - store and/or warehouse locations; and
 - strategic business expansion and/or development.

- Marketing and media planning:
 - sales force locations and/or territories;
 - sales prospecting;
 - market analysis of customers, competitors or outlet densities;
 - market analysis of direct mail responses;
 - poster distribution;
 - TV and/or radio advertising regions; and
 - product and/or brand promotion campaigns.
- Financial/Insurance:
 - customer bases; and
 - high/low risk areas.
- Health:
 - community health; and
 - health black spots.
- Leisure activities:
 - large site planning, for example, golf courses;
 - tourism; and
 - theme park locations.

What you need to use Meridian 2

Computer hardware

This product may be used on a wide range of hardware platforms (provided sufficient memory and storage facilities are available), varying from desktop PCs using GIS or CAD to mainframe computers with specialised translators and applications.

Computer software

Meridian 2 is supplied as inert data and does not include software for data manipulation. To exploit fully the potential of Meridian 2 it is necessary to use appropriate application software such as GIS or CAD.



NTF allows users of GIS to customise their own definition of the data and/or plotting for their specific applications. The parameters defining colours, line styles, text styles, symbols and so on should be built into user software. Meridian 2 may be customised by viewing or plotting features in different colours, line styles and scales to suit different applications. Certain classes of features may be omitted from customised plans on the basis of selection by feature code.



DXF is designed for use with Autodesk® Ltd CAD software, particularly AutoCAD. The parameters defining colours, line styles, text styles, symbols and so on are embedded within the DXF file, as is customary with this CAD format.

Please check with your supplier if you are unsure of your CAD system's compatibility with Meridian 2.

Meridian is also available as data in Mid/Mif and shapefile formats which require specific software such as MapInfo® Professional or ArcView®.

Supply

Meridian 2 supply options

The options for data supply are as follows:

- Combined theme: All layers.
- Communication theme: roads and railways, boundaries and coastline.
- Topographic theme: boundaries and coastline, developed land use areas (DLUAs), cartographic names, hydrology, woodlands and gridded height.

NOTE: gridded height is supplied with the Meridian 2 options but on a separate CD.

All themes are available as:

- Complete national cover of Great Britain (2 857 tiles).
- England.
- Scotland.
- Wales.

(These areas correspond with Nomenclature des Unites Territoriales Statistique (NUTS) Level 1 Areas.)

- 10 km by 10 km tiles.

Meridian 2 supply formats

Meridian 2 is available in:

- NTF BS 7567 v2.0 Level 3; or
- DXF (conforming to AutoCAD release 12 with extended entity data).

Meridian 2 supply media

NTF is supplied on CD-ROM only.

DXF is supplied on CD-ROM only.

Chapter 2 Overview of Meridian 2

Data overview

Basic principles

Links represent roads, railways, administrative areas, coastline, developed land use area, inland water and woodland area lines.

Nodes represent all intersections of links within each layer, changes in attributes in links and link ends.

Each feature has associated geometry; this may be a single coordinate pair for a single point feature for a railway station, or two or more coordinate pairs for a linear feature.

Each feature is classified by means of a feature code.

Roads, railways, railway stations, administrative area seed points, developed land use area seed points, inland water and woodland area seed points have unique identifiers.

Meridian 2 vector data structure

Meridian 2 data within each layer is supplied as vector data, in a link and node structure. Geographical features are represented as data entities, either as points or lines. Points are fixed positionally by one coordinate pair, for example, a railway station. Lines are fixed positionally by a series of connected coordinate points to represent linear map features such as roads, railways and so on. Points and lines within the data model determine the **geometric** (positional) characteristics of the data.

Points and lines within the data model also have associated attributes. These give the point and line entities meaning, that is, they represent the descriptive characteristic of an entity such as a feature code, a name or numerical value. Lines are also added as closing links (neat lines) along tile edges; these are required to complete the enclosure of an area. The closing link has a different feature code to the other links enclosing the area.

Throughout Meridian 2 no line feature crosses from one tile to the next, but a point feature created at the tile edge has the same coordinate value as its partner on the adjacent tile.



All features having the same feature code are recorded on the same layer. DXF has a limited *link* and *node* structure; within this structure, a feature may be a name, point, or line. Each feature is freestanding, that is, its topological relationship to any other feature is not expressed in the data.

Other important data structure concepts include **networks** and **polygons**.

Networks are interconnecting features structurally related by means of an explicit point described as a node. Between the nodes are series of non-intersecting line segments described as **links**; hence link and node – see [figure 2.1](#). This is of special interest in GIS where there may be a need to analyse the network in order to follow routes or to close polygons.

Proprietary GIS software can be used to build and maintain networks for linear features such as roads, railways and so on, and provides the functionality to store, manage and manipulate this data.

The properties of Meridian 2 make it a suitable basis for users wishing to develop applications using Meridian 2 together with their own data. As Meridian 2 is based on the National Grid, there is a simple way of overlaying users' own data provided the position is given within the National Grid.

The National Grid as it applies to Meridian 2 is explained in [chapter 5](#).

Figure 2.1: Link and node

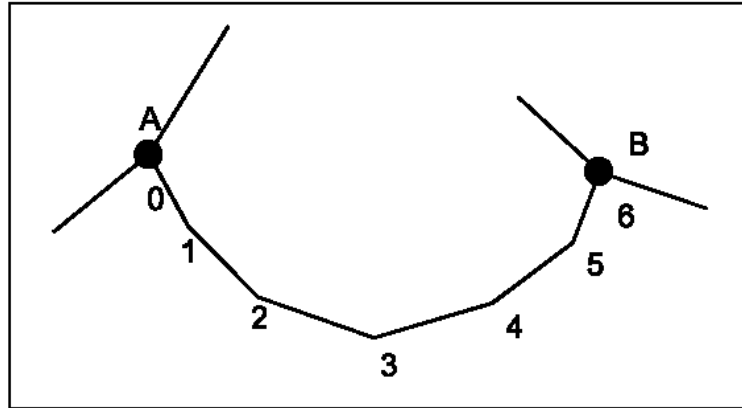

Points A and B are nodes, as they intersect with other features. The line A–B is the link, and, in this example, is made up of six individual line segments.

Polygons are continuous areas defined by sets of bounding closed lines. These are implicit within the data, but can be explicitly created with appropriate software. Stored within recognisable polygons are **seed points**, which hold information about that polygon, for example, a county name.

Figure 2.2: Polygon

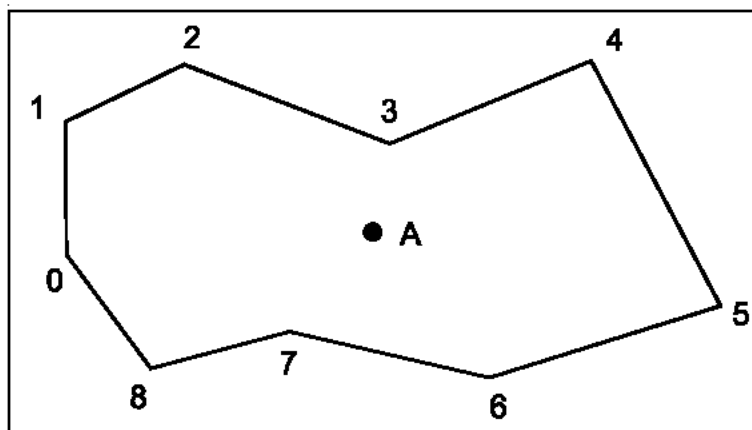

Point A is the polygon seed point for the area: attached to this point are attributes such as the feature code, which defines the polygon and its definitive name. These attributes may be transferred to the polygon itself. The polygon in this example comprises nine individual line segments.

There are also free-standing points, which are not associated with a defining polygon, for example, Liverpool Lime Street Station.

Chapter 3 Meridian explained

Features

Meridian 2 has two feature classes:

- Point features.
- Line features.

Point features such as administrative area seed points and line features such as roads, railways, and developed land use areas are arranged into recognisable categories. A full listing of individual features is given in [chapter 6](#).

Each feature has two components:

- Feature position.
- Feature attribute data.

Also explained in this chapter:

- Feature layer descriptions.



Each feature recorded in Meridian 2 should be considered as a DXF entity. Line features are recorded as DXF Line(s) or Polyline(s).

Point features will be recorded in the data as INSERT BLOCKS. Certain standard symbols are defined in the BLOCKS section of the data file. A list of these standard symbols is shown in [chapter 8](#). Attributes are stored as extended entity data.

Points and lines

Real-world geographic features are represented in the digital map data as structures of lines and points. Each point or line has a geometric and attribute component.

The geometric component defines the positional characteristic of the feature, and implicit relationships exist between points and lines based on relative position. The attribute component defines the descriptive characteristics of the feature.

Points may exist independently of lines.

A diagrammatic example of a geometric structure is shown in figure 3.1a.

Figure 3.1a: A geometric structure of points and lines.

Solid black, grey and broken grey lines and associated points are on different layers.

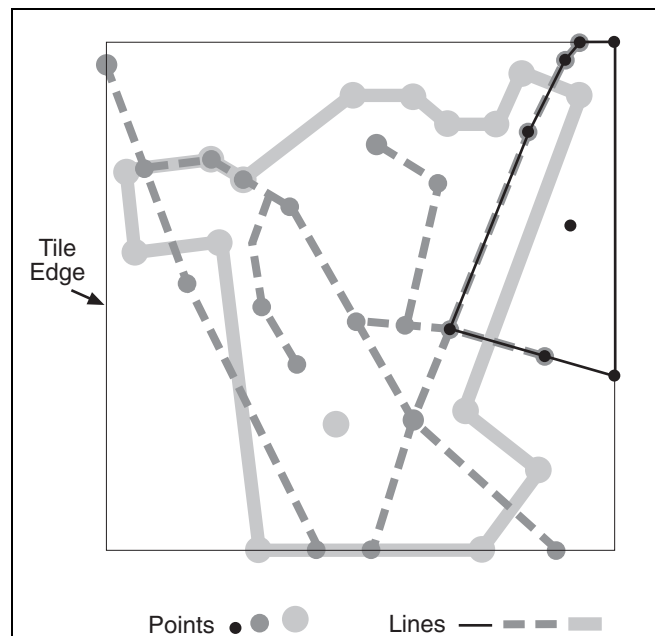

Points and lines from the geometric structure become features when an attribute, the feature code, has been added, for example, developed land use area seed points are created from points, or developed land use area boundaries from lines.

Figure 3.1b: The same geometric structure as features

Solid black, greys, and broken grey are on different layers.

In figure 3.1b:

Point A is a seed point with a feature code that identifies it as a developed land use area; the seed point also carries its name attribute – Bryncethin.

Point B is a coordinate junction between intersecting features – in this case, where a minor road intersects with the A4061. This is an example of a node.

Point C is a position where the A4061 in one layer crosses the developed land use area boundary in another layer. There is no node at this point.

Some points and lines are common to more than one feature, as in figure 3.1b. Features between D–E and G–B–F are overlapping features and are stored separately within each layer of data.

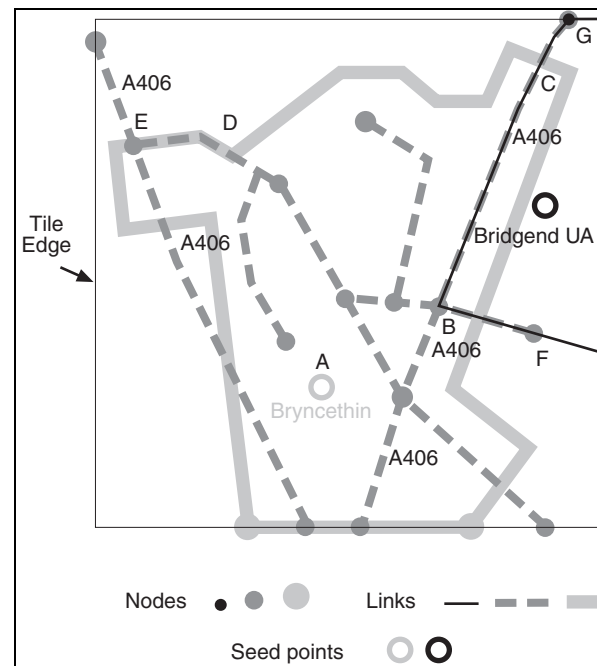

Separate storage of overlapping features

Figure 3.1c: Roads

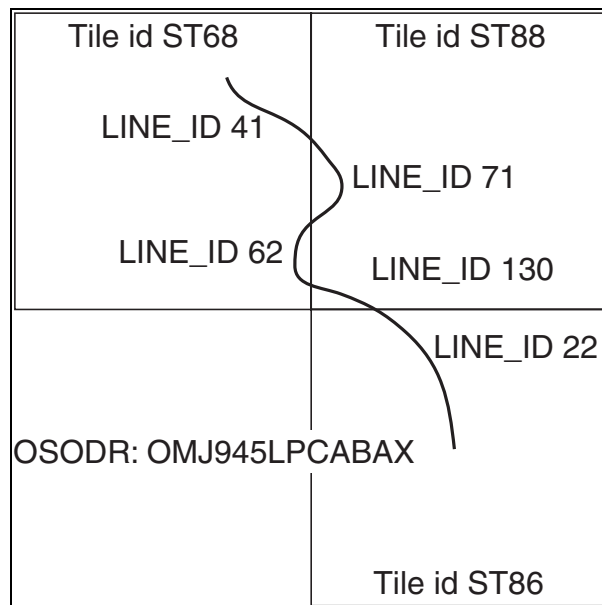
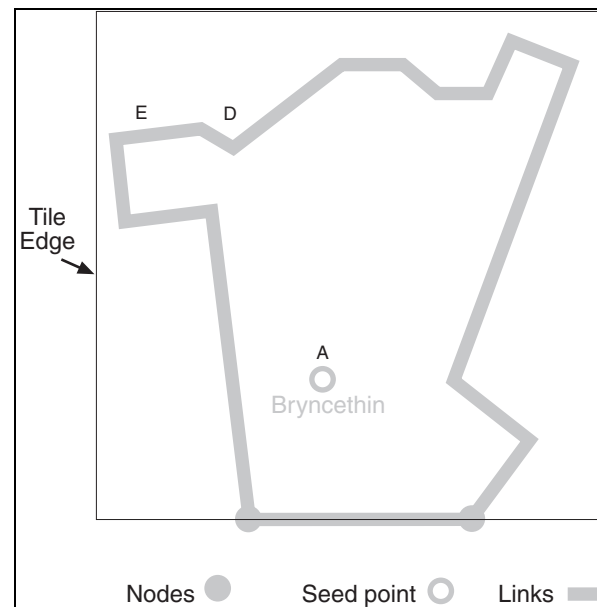
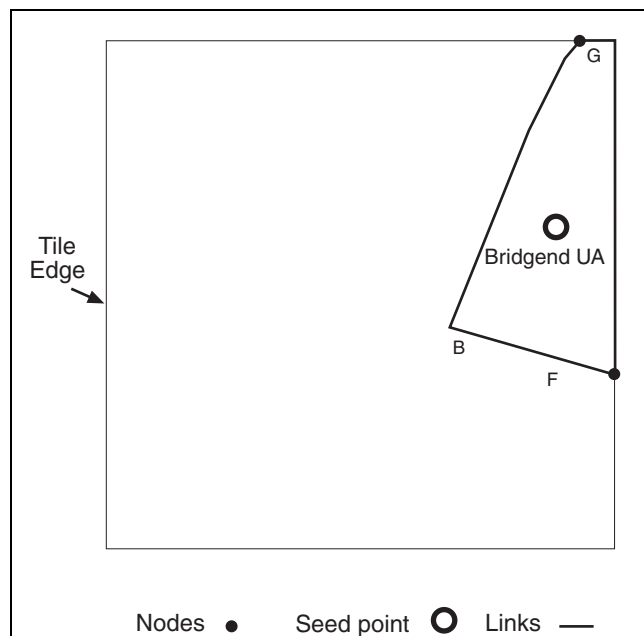

Figure 3.1d: Developed land use area



In figures 3.1c and 3.1d line D–E is common to the minor road and the developed land use area boundary and the geometry of each feature is stored separately.

Figure 3.1e: Administrative areas and coastline



In figures 3.1c and 3.1e line G–B–F is common to the A4061, the minor road and administrative area boundary and the geometry of each feature is stored separately.

Feature position

The geometry of map features is defined in terms of coordinates. All coordinates used in Meridian 2 are based on the National Grid coordinate referencing system, and are quoted to a resolution of 1 metre.

The National Grid, as it applies to Meridian 2, is explained more fully in [chapter 5](#).

Feature attribute data

An attribute is the descriptive characteristic of a feature, that is, a non-spatial element.

The geometry of the points and lines within the data would be meaningless to the user unless they are assigned some distinguishing property. In Ordnance Survey map data terms, an attribute can be a feature code (in NTF these are numeric codes), for example, 3000, or a distinctive name or number, for example, Birmingham or M40.

Attribute codes relevant to NTF are listed and described within [chapter 6](#), but an overview is given below.

Feature codes

Each feature is classified by means of a feature code (FC). A feature code is allocated when each feature is initially interpreted and captured from the map base. In this way, an A road is distinguished from a B road and other kinds of line feature by the feature code allocated to it.



Each feature is classified as belonging to a specific feature code. These feature codes are listed in [chapter 6](#).



Each feature is classified as belonging to a specific feature layer. These layers range in value from G8050570 to G8056801; see the AutoCAD publication *Layer Naming Convention for CAD in the Construction Industry*, version 2, based upon guidelines in BS 1192: Part 5 – *Guide for structuring of computer graphic information*. These feature layers are listed in [chapter 8](#). Attributes are stored as extended entity data.

An additional text feature code for layout of footnotes is included. This feature code is listed in [chapter 8](#).

In order to display the attributes stored as extended entity data, the following two scripts are required. These two files, 'Showeed.lsp' and 'Showeed.dcl', are contained in the 'EXE' directory on the Ordnance Survey-supplied CD-ROM and should be placed in a directory in the AutoCAD preferences search string. This should include the directory containing the map data files in DXF.

To utilise the scripts, type the following at the AutoCAD command line prompt within a drawing session:

```
AutoCAD:      (load "showeed")
```

```
AutoCAD:      eedd
```

Selecting a map feature will now display the allied attributes of that feature in a dialogue box. To interrogate other features, the Re-Select option on the user dialogue box should be chosen. The Cancel option will return the user to a normal AutoCAD session.

If the eedd command is repeated at the command prompt, the facility will again be available to the user.

The visibility of extended entity data to software other than AutoCAD Release 12 will be constrained by the functionality of those individual software applications.

These differences in the data are inferred during translation from Ordnance Survey's internal data format to the required customer transfer format.

Names as attributes

The criteria for names attribute attachment are:

- **Admin name (NM)** is an attribute of a seed point in its administrative area, for example, Hampshire County.
- **Proper name (PN)** is an attribute of a seed point in a developed land use area, for example, Bexhill, or a node point for a railway station, for example, Great Ayton Station.
- **Text (TX)** is a text string transferred in an attribute record to be displayed as stand-alone cartographic text, for example, Southampton – a place name.
- **Hydrology (WA)** is an attribute of a seed point in a water area.
- **Woodlands (FA)** is an attribute of a seed point in a woodland area.

Road number (RN) attribute

This attribute defines the DfT road classification number, for example, M40 that relates to a **link**. If a road is not classified then this attribute will not be present.

Trunk road (TR) attribute

This attribute defines whether the **link** forms part of a trunk road. If it is then the link will have a trunk road attribute with a value of Y and if it is not a trunk road then there will be no value in this field.

Line length (LL) attribute

This attribute defines the length of the link in metres and will be present for all **link** records. It is calculated from the planimetric coordinates making up the link and does not take into account the effect of slope. The link length in all products refers to the length as recorded in the OSCAR[®] database.

OSODR attribute

This attribute defines the Ordnance Survey ROADS Database Reference (OSODR). This will uniquely identify any link or node within the national OSCAR dataset. The OSODR will be used as the unique identifier for each link and node, rather than the NTF identifiers. The NTF identifiers will be unique within each tile that is supplied but will not be maintained between supplies.

A road object is part of a road between nodes (junctions) uninterrupted by tile or map edges.

An OSODR refers not just to a single link but may refer to many links that make up a road object – which may be chained together across tile edges. Thus, on adjoining tiles there may be two or more links with the same OSODRs. This attribute applies to links and nodes. It will be present for all features.

An OSODR has been assigned to all existing features (links and nodes) in the OSCAR database. Any features that are new to ROADS after the initial allocation will be assigned an OSODR when they are loaded to the database.

The OSODR for a feature will never be modified – only created and deleted. However, there may be many changes to a feature with a specific OSODR during the lifetime of that OSODR allocation. There are two reasons for changes. These are:

- 1 the coordinates of the feature may move within a specified tolerance – currently 3 m either side of a link, 10% of its length, and 5 m movement of any node; or
- 2 the attributes associated with a feature may change. Any changes to these attributes will not affect the OSODR allocated to that feature.

The following attributes may change for **link** features:

- date of survey of conversion;
- feature code;
- length of link;
- road name;
- road number; and
- trunk road indicator.

The following attributes may change for **node** features:

- direction of links at node;
- feature code;
- junction name;
- number of links at node;
- level of link at node; and
- settlement name.

If a feature moves by more than the specified tolerance, then the OSODR for the feature will be deleted and a new OSODR allocated to that feature. If a feature is deleted from the OSCAR product and the ROADS database, then the OSODR allocated to that feature will cease to exist and will not be reallocated.

Link level at node

The level field in Node Record 16 indicates – for roads – the relative height relationship between intersecting links at a node. It does not relate to ground surface level. If a road over a bridge can be accessed then a level value of 0 is used; a value of 1 used when there is no access from one road to the other at an intersection. See figure 3.2.

Figure 3.2: Grade separation

In this instance, the single node will show a level 0 for all links in Node Record 16 as it is possible to access any carriageway from any approach road.

A bridge over a road that cannot be accessed will show a level value of 1.

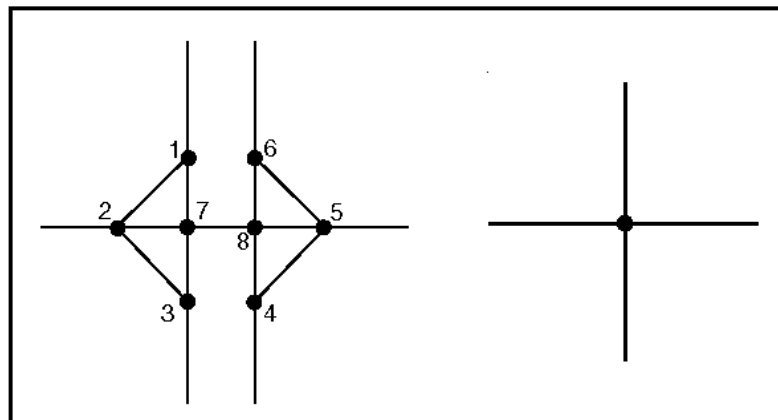

Proper name (PN) attribute

This attribute defines the road name associated with any link in the ROADS database. If a link does not have a proper name then the attribute will not be present. Where the road is otherwise not named and part of a named estate, the estate name will be allocated to the road.

Roundabout (RT) attribute

This attribute defines whether a node is a generalised representation of a roundabout in the Meridian 2 road data. If it is, then the node will have a roundabout attribute with a value of Y.

Junction name (JN) attribute

This attribute indicates the junction number of motorway junctions and the other classified roads at that junction. The junction name is variable length text, and is in the format M6J10A, where M6 is the DfT road number, and J10A indicates that this is the junction numbered 10A of the M6. If the junction has no junction number, then that part of the junction name is not supplied.

There could be any number of roads at a junction, therefore each classified road at that junction may be repeated in the junction name attribute. An oblique character (/) separates each road number and junction. The following is an example of a junction name attribute:

M40J1/A40/A413/A4020

This attribute only applies to **nodes**. If the node does not have a junction name, then this attribute is not present.

Settlement name (SN) attribute

This attribute defines the name of a location or settlement. This name will be attached to the node that is closest to the position of the location or settlement.

Unique identifiers

Unique identifiers are used to uniquely identify some features within Meridian 2. These are:

- **OSODR attribute** defines the Ordnance Survey ROADS Database Reference (OSODR). This will uniquely identify any link or node within the national OSCAR dataset.
- **Railway and railway station identifiers.** These uniquely identify any railway link or railway station within the national Meridian 2 database.
- **Developed land use area identifier.** This uniquely identifies any developed land use area seed point within the national Meridian 2 database.
- **Global identifier.** This uniquely identifies any administrative area seed point within the 10 km by 10 km tile.
- **Forestry identifier.** This identifies any forestry area seed point.
- **Hydrology identifier.** This identifies any hydrology area seed point.

The unique identifiers are unique references and will be maintained, except where there has been significant change to a feature.

The unique identifier may refer to several links representing a linear object across tiles, for example, a road or a railway, which may be chained together across tile edges. Thus, on adjoining tiles, there may be two or more links with the same unique identifier. See [figure 3.3](#).

Figure 3.3: Unique identifiers

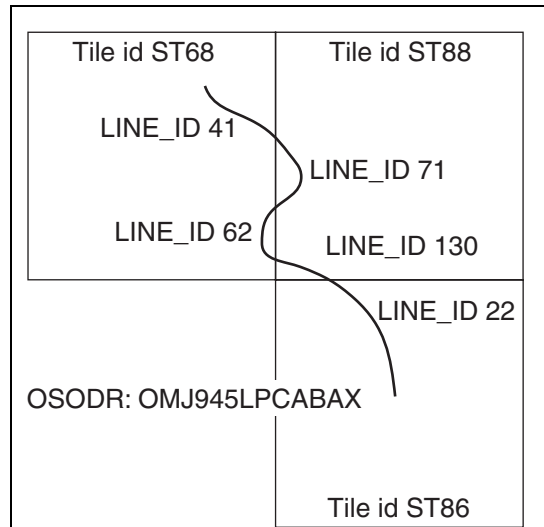

Unique identifiers have been assigned to all existing roads (links and nodes), railway links and railway stations and to seed points for administrative areas, developed land use areas, hydrology (inland water) and woodlands. Any of these features that are new to Meridian 2 after the initial allocation will be assigned an appropriate unique identifier when the database is refreshed.

The unique identifier for a feature will never be modified – only created and/or deleted. If a feature is deleted from the Meridian 2 database, then the unique identifier allocated to that feature will cease to exist.

Feature layer descriptions

The feature codes that appear in Meridian 2 within each layer are detailed in [chapter 6](#). The individual layers are described below.

NOTE: Names or numbers appear in all layers as attributes. The roads layer is the first hierarchical layer; the other layers will be manipulated to fit in the following 1–8 hierarchical order.

1 Roads

Motorways, major and minor roads are represented in the data. Complex junctions are collapsed to single nodes and multicarriageways to single links. To avoid congestion some minor roads and culs-de-sac less than 200 m are not represented in the minor road feature description of the data. Private roads and tracks are not included.

Hierarchical position 1.

2 Railways

All railway stations open to passengers and single-track passenger lines are represented.

A railway intersection consists of links and a node, but where railways cross at different levels, links are not broken. Links and nodes carry a feature code.

If the station name differs from the name of the built-up area on Ordnance Survey's large-scale data, for example, New Street Station in Birmingham, or if the railway station name is not associated to any built-up area name, for example, Great Ayton Station, then the points will carry a railway station name. Node attributes will also be shown as cartographic station names.

To maintain positional relationship, features in this layer may be adjusted and fitted to the roads.

Hierarchical position 2.

3 Administrative areas and coastline

Administrative areas include information for unitary authority areas for Scotland, Wales, county, district and London borough boundaries for England.

Figure 3.4: Hierarchical relationship of boundaries for England

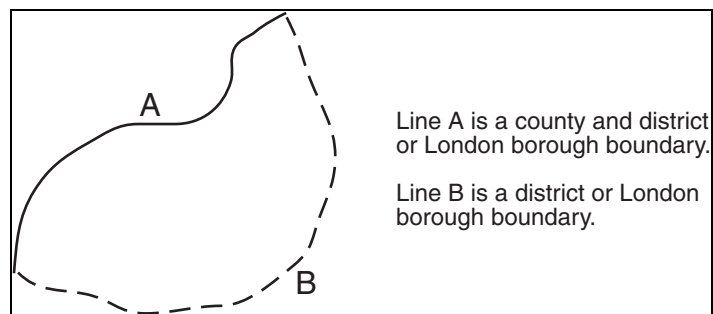

Each link for an administrative area carries a feature code and the administrative level associated with the left and right sides of that link. This also applies to coastline, but only to the landside of the coastline, that is, no administrative area information is added to the seaward side.

Each administrative area contains a seed point that identifies the enclosed area and carries a feature code and the associated administrative area name. Separate areas of the same administrative unit carry seed points with different identifiers.

Offshore islands carry a county and district or unitary authority seed point. There is no logical connection in the data between them and administrative units other than the same name attribute.

There is no explicit information to identify which links form the bounds of a particular area. The left and right county and district pointers on links do not contain the name of the administrative area, but refer to the seed point that has the administrative area name as its attribute.

The coastline follows the mean high water (MHW) up all estuaries to the normal tidal limit (NTL). Administrative areas are only shown down to MHW.

The administrative areas are adjusted to the coastline.

To maintain positional relationship, features in this layer may be adjusted and fitted to roads and railways.

Changes to the local authorities of Wales and Scotland that have taken place between April 1998 and May 1999 have been incorporated in the Meridian 2 database.

Local government in England is still under review although some counties have been concluded.

Hierarchical position 3.

4 Developed land use areas

Developed land use area features include cities, towns, villages and industrial, commercial and business parks.

Link features enclose developed land use area features. Such areas contain a seed point that identifies the enclosed area and carry a feature code and the associated developed land use area name. **There is no explicit information to identify which link forms the bounds of a particular area.**

The whole developed land use area has been positioned to the road pattern by best fit practice.

Hierarchical position 4.

5 Cartographic names

Place names from the small-scale database and railway station attribute names are shown as independent text features and located near the feature that they describe.

Place names are collapsed from double-banked, treble-banked or composite text to a single text feature with all the text as one string.



The text font STANDARD and text height in metres have been used for these cartographic names and are as layers separate from the feature with which they are associated. These are the text font identifiers:

0001 has been used for railway text (Times Roman – non-italic)

0002 has been used for settlement text (Helvetica® bold – sans relief)

0003 has been used for water text (Times Roman italic – sans) these are transferred with the text feature

0004 has been used for town text (Univers® medium Roman condensed) and text height in millimetres.

The Ordnance Survey convention for the digitising of names is as follows: all names are digitised as point features, given as X and Y National Grid coordinates. The point has been digitised relative to the map feature it describes, and the actual point represents one of the standard positions shown in [figure 3.5](#).

Figure 3.5: Standard Ordnance Survey text positions

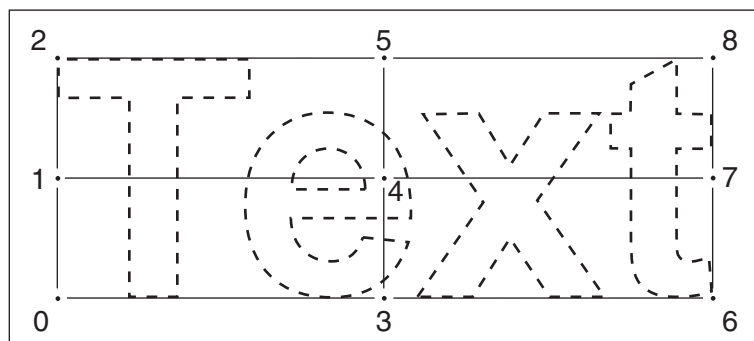

Names are normally placed on the printed map parallel to the horizontal grid.

DXF

Position 0 is supplied.

BS 7567
NTF

The text string may start, end or be centred on this coordinate pair; the relationship of the text to its coordinate pair is expressed as an original digitised position. Where the position of text features is recorded, one of these positions is digitised. Hierarchical position 5.

6 Hydrology

Each water area contains a seed point identifier that carries a feature code and the associated attribute. Each link for water boundaries carries a feature code.

To maintain positional relationship, features in this layer may be adjusted and fitted to the hierarchy. See the note at the beginning of [feature layer descriptions](#) earlier in this chapter.

Dark links have been used to maintain the connectivity of the network across lakes and reservoirs. Where links entering and leaving the lake or reservoir carry the same name, the dark link is attributed with this name.

Hierarchical position 6.

Figure 3.6: Dark link diagram showing connectivity

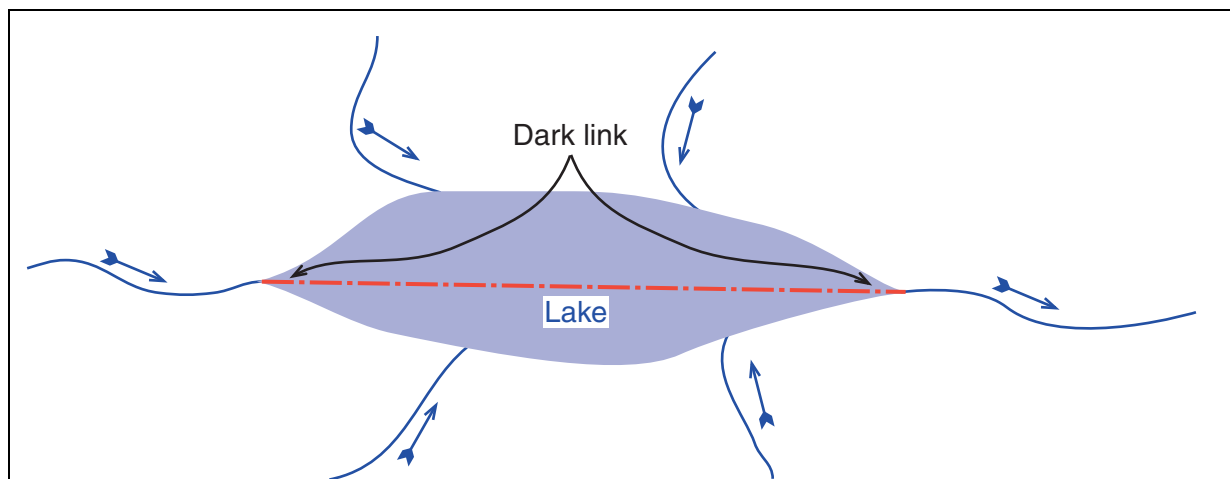

A river and tributaries flow into a lake. The amalgamation of these is a dark link running through the middle of the lake and outputting as a river again.

7 Woodlands

Each link for woodland boundaries carries a feature code. Each woodland area contains a seed point identifier, which carries a feature code and the associated attribute. To maintain positional relationship, features in this layer may be adjusted and fitted to hierarchy.

Hierarchical position 7.

8 Gridded height

Height information is produced in the form of digital terrain model (DTM) style data.

Gridded height information is averaged from the 50 m resolution Land-Form PANORAMA[®] dataset to a resolution of 200 m and rounded down to the nearest 1 m value.

Chapter 4 Quality statement

Source of Meridian 2

Meridian 2 data are derived from large-scale and small-scale digital databases. The data capture source and scales are:

| Feature | Original data source | Source scales |
|---|--|-----------------------------|
| Road network | ROADS centre-lines OSCAR Route-Manager® | 1:1250, 1:2500 and 1:10 000 |
| Railways | Large-scale database | 1:1250, 1:2500 and 1:10 000 |
| County, district and London borough for England | Boundary-Line™ | 1:10 000 |
| Unitary authority areas for Wales | Boundary-Line | 1:10 000 |
| Unitary authority areas for Scotland | Boundary-Line | 1:10 000 |
| Coastline | Landranger® | 1:50 000 |
| Developed land use areas and place names | Strategi® | 1:250 000 |
| Hydrology | Strategi | 1:250 000 |
| Woodlands | Strategi | 1:250 000 |
| Gridded height | Land-Form PANORAMA | 1:50 000 |

Currency

Meridian 2 data is derived from the latest available versions of Ordnance Survey's databases. The Meridian 2 dataset will be refreshed annually commencing in January 2002.

The large- and small-scale databases are controlled by the revision criteria for topography that are defined by Ordnance Survey for the various geographical areas.

Accuracy and resolution

The resolution of the data supplied is 1 metre. Meridian 2 data retains the same accuracy as the source data during its capture. However, it is not possible to calculate meaningful accuracy criteria for these data due to different source databases.

OSCAR Route-Manager has a 20 m filter applied to the centre line, which is supplied to 1 m resolution. The 20 m filter does not affect the positional accuracy of node points.

During the updating of OSCAR data there is a comparison buffer created – around the existing OSCAR data – to detect change. This buffer is set to 3 m either side of a feature, 5 m at each end, and 10% of the length.

Administrative areas and roads data have a 20 m lateral filter applied to the boundary and centre lines. The 20 m filter does not affect the positional accuracy of node points.

Features derived from the small-scale databases have been subjected to generalisation – information is cartographically represented in areas where accurate positional representation would cause confusing clutter on the viewed image. To maintain positional relationships such data has been further adjusted to fit the hierarchy where necessary.

Completeness

During production, many checks are undertaken to ensure that data supplied to customers are both accurate and complete. During digital manipulation in creating the upgraded data, all sources of that data are checked against specification documentation to identify whether any features have been omitted or misaligned.

These quality control checks take the form of:

- visual checks by operators;
- independent quality assurance checks; and
- computer validation with the specification.

Meridian general specifications

The following gives details of the product specification identity and its relationship to Ordnance Survey data capture specifications. Version details of these specifications are also stated.

| Product | Product specification | |
|---------------------------------------|------------------------------|------------------|
| Meridian 2 | Meridian_02.00 | |
| Transfer format specifications | | |
| Name | NTF (BS 7567) | DXF (Release 12) |
| Level | 3 | |
| Version | 2 | 1 |
| Issue date | 15 May 1992 | 1 January 1997 |

Chapter 5 The National Grid

Meridian 2 tiles are identified by quoting the National Grid reference of the south-west corner of the area they cover. The Ordnance Survey National Grid divides Great Britain into squares 100 km by 100 km. Each of these squares has a unique two-letter reference, for example, TG in the diagram below.

Each Meridian 2, 10 km by 10 km tile is described by adding a two-digit reference to the 100 km by 100 km square reference, with the easting first followed by the northing, for example, TG23.

For additional information on how to use the National Grid, visit Ordnance Survey's web site at: www.ordnancesurvey.co.uk.

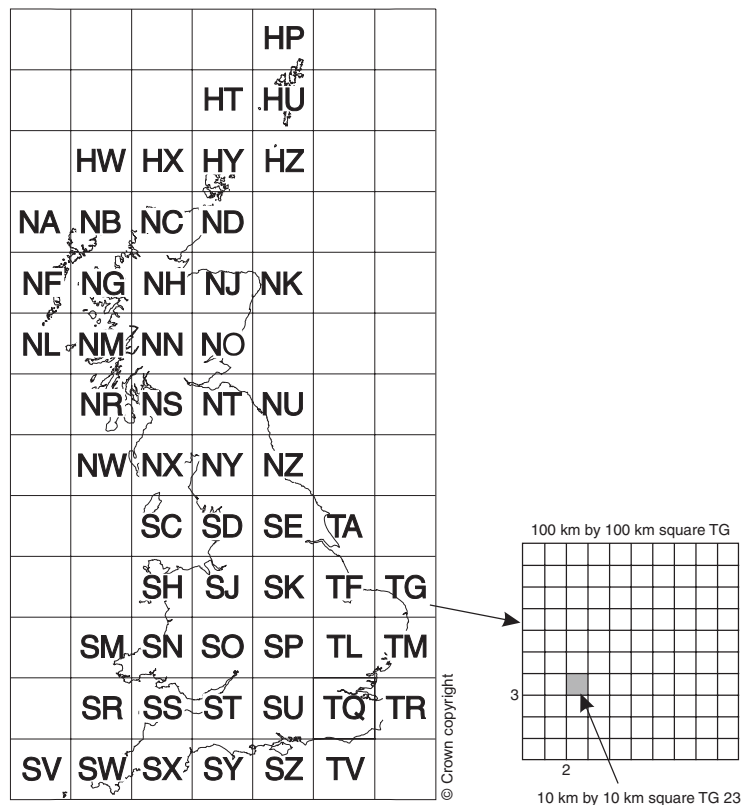

Chapter 6 NTF explained

An overview of Meridian 2 in NTF

This chapter gives a detailed breakdown of the data structure of Meridian 2 in NTF.

Meridian 2 data is supplied in the British Standard national format common to all Ordnance Survey's digital map data products – namely NTF – and is transferred in Level 3 as variable length records. An overview of the data structure of a Meridian 2 data file is on the following page. The convention used for this diagram is in the industry standard adopted for Jackson Structured Programming (JSP).

The British Standard for NTF stipulates the following for Level 3:

'This level supports a variety of data models that may include network data, polygons, semantic relationships and complex features – for example, a school consisting of its buildings, boundaries and playing fields.'

This level is designed for:

- Transferring basic geometry and simple features through the use of geometry and feature records.
- Relating basic geometrical and topological elements to one or more features through the use of chain, polygon and complex line records.
- Combining features to form complex features through the use of collection and complex polygon records.
- Using text records both to relate text strings to features and cartographic output.
- Referencing and positioning external features, for example, raster data.

The record structure at this level may also be defined to be compatible with data in Levels 1 and 2.

There are certain conventions used in this user guide, which are:

- [] Square brackets are placed around record names, for example, [VOLHDREC].
- { } A pair of braces denote field names, for example, {REC_DESC} is the Record Descriptor field.
- [] 90 A two-digit number following square brackets denotes the record descriptor that uniquely identifies the record name between the brackets.
- <S> This is the space character (ASCII code 32).
- <3S> This denotes three successive space characters.
- % The percentage character (ASCII code 37).
- | This denotes a repeating group (ASCII code 124).

Jackson structure

The following diagrams are examples of Meridian 2 files and no fixed record sequence or relationship is implied.

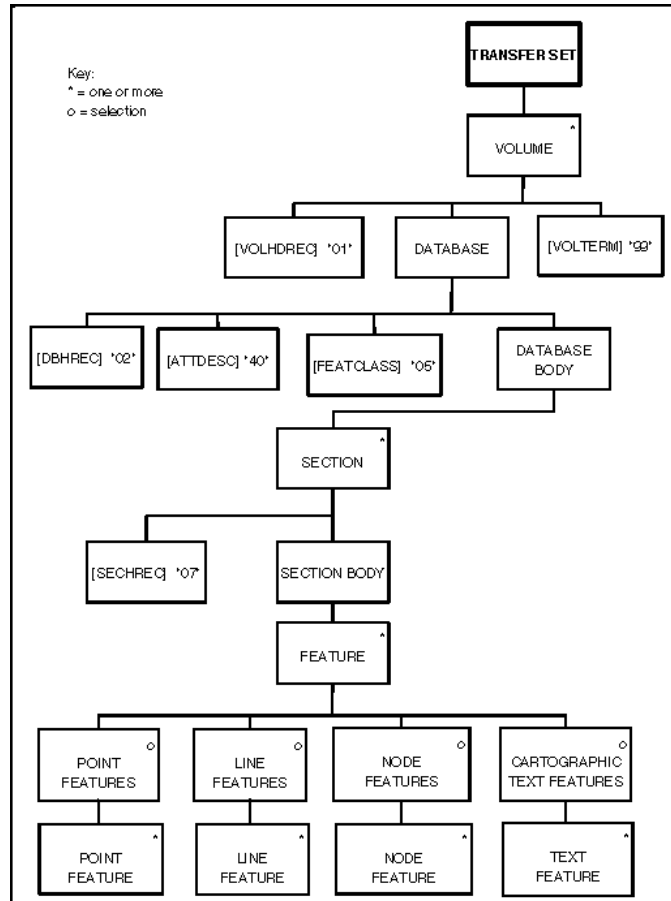

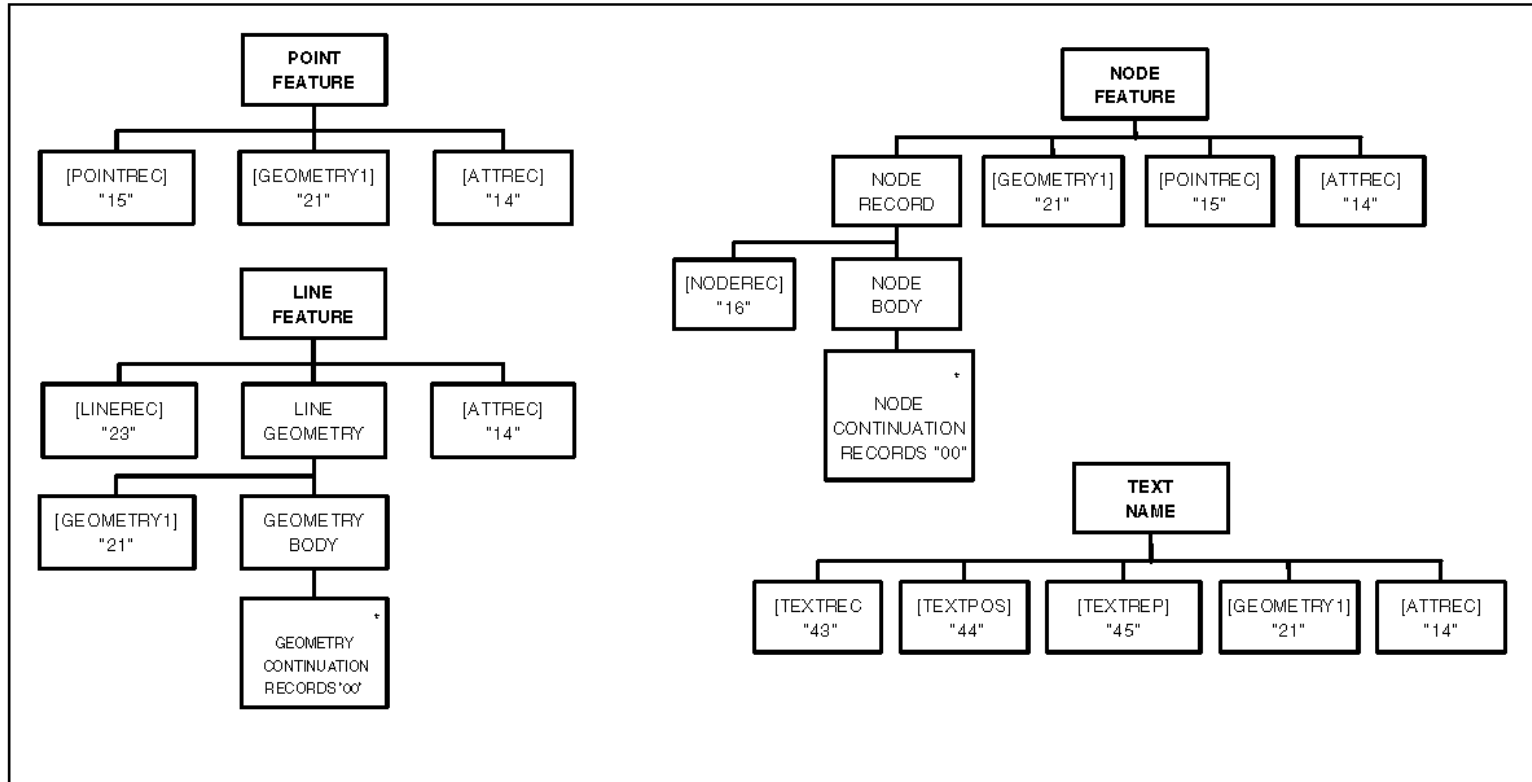

The governing body for the industry standard NTF is the British Standards Institution (BSI).

Their address is:

British Standards Institution
389 Chiswick High Road
LONDON
W4 4AL

Phone: +44 (0)20 8996 9000
Fax: +44 (0)20 8996 7001
Email: cservices@bsi-global.com

Any queries relating to the Meridian 2 product should be referred to the Sales Information Helpdesk at the address given in [Contact details](#) at the beginning of this user guide.

Transfer set structure

Record size

NTF data is written to the output device in variable length records, with a maximum record length of 80 characters, which includes {CONT_MARK} and {EOR}.

Record terminator {EOR}

The end of record terminator is the percent (%) (ASCII 37) character for both formatted and unformatted media.

A transfer set normally equates to a single file except where continuation volumes are used when the transfer set exceeds the capacity of the media. The data the customer receives is in one or more transfer sets. Each transfer set starts with a [Volume Header Record](#) [VOLHDREC] and terminates with a [Volume Terminator Record](#) [VOLTERM].

Supply of data on formatted media

Data requested on CD is not blocked, but is written directly to the output device. The transfer set has one dataset and one section. One or more transfer sets are put onto the medium. A customer's order that is larger than the capacity of the medium is put onto two or more of that media. Continuation volumes are only be used if a transfer set is larger than the capacity of the medium.

Formatted media (transfer set less than media capacity)

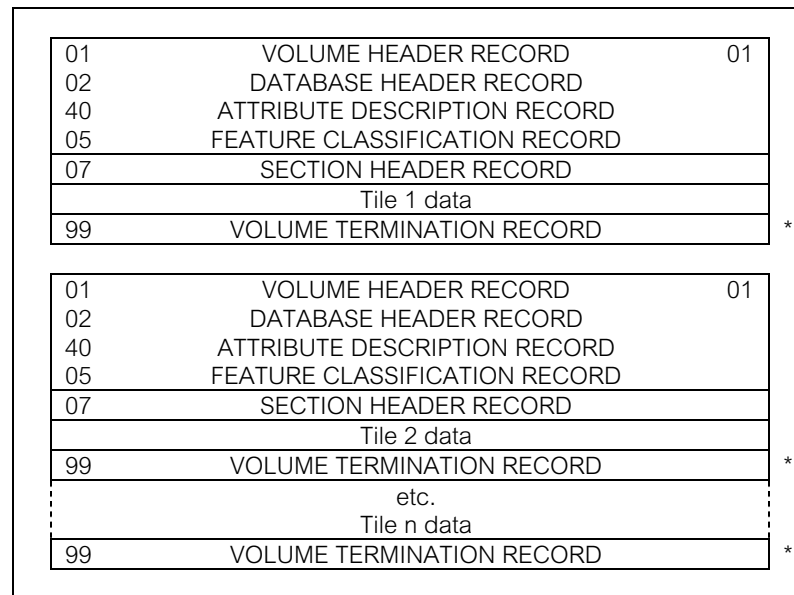

* '99End Of Transfer Set 0%'

Formatted media (transfer set greater than media capacity)

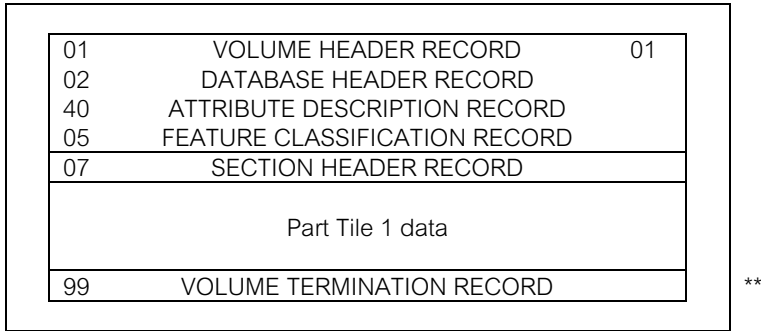

** '99 End Of Volume 01 Transfer Set
Continues On Volume 021%'

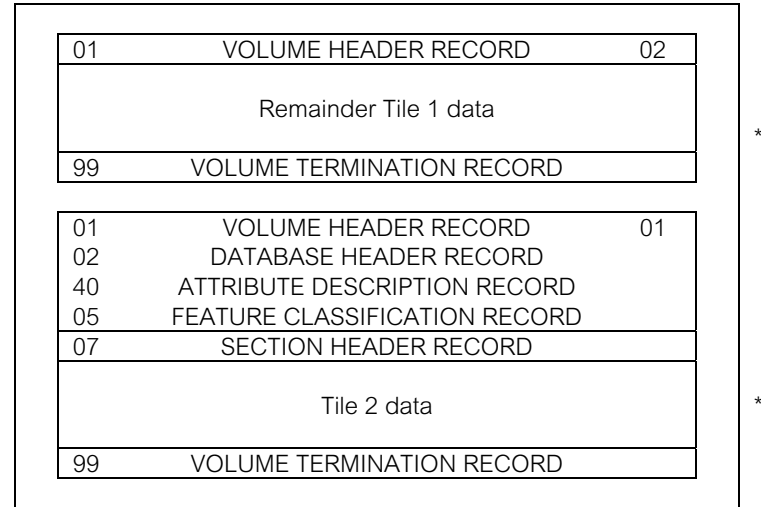

* '99End Of Transfer Set 0%'

The beginning of each transfer set is structured with the following introductory, or leading, records:

Database Header Record [DBHREC] – this gives details of:

- 1 The database name.
- 2 NTF release date.
- 3 Feature classification table name.
- 4 Release date that applies to the whole of the transfer set.

[Attribute Description Record \[ATTDESC\]](#) – this lists and gives a description of the attributes that can be applied to features within the transfer set.

[Feature Classification Record \[FEATCLASS\]](#) – this lists and gives descriptions of all possible feature codes for the transfer set.

These introductory records are followed by the data requested by the customer that are contained in the *section*.

The *section* consists of two parts:

- 1 [Section Header Record \[SEHREC\]](#): this gives the National Grid coordinates of the *section* and on unformatted media informs the customer that a new *section* is starting.
- 2 **Section body**: this comprises all the features within the *section*.

Version management

Each version and release of all Meridian 2 products is defined by a unique product version number and release number – these are reflected in this user guide. The product version number relates to the specification of the data being supplied, and the release number relates to the release of the product.

The **product version number** takes the form **xx.yy**, where xx is the major product number, and yy is the minor change number. Thus version 02.00 would indicate that this is the major product version 02, and that the 00 indicates no minor amendment to the product specification.

The **release number** takes the form **xx.yy**, where xx is the sequential release within a year, and yy is the year of the release. Thus release 01.01 would indicate that this is the first data release in 2001.

The product version number and the release number are specified in the [Database Header Record \[DBHREC\]](#), as supplied in NTF.

General

The following are the record definitions for the transfer of Meridian 2 data in NTF:

- [Volume Header Record](#) [VOLHDREC]
- [Database Header Record](#) [DBHREC]
- [Feature Classification Record](#) [FEATCLASS]
- [Attribute Description Record](#) [ATTDESC]
- [Section Header Record](#) [SECHREC]
- Section body – see Point and line features
 - name detail
 - node detail
- [Volume Terminator Record](#) [VOLTERM]

Section body

This comprises all the features within the tile that correspond to the feature types selected by the customer.

Point and line features

Point feature

Each point feature is depicted by the use of the following records:

| |
|------------------|
| POINT RECORD |
| GEOMETRY RECORD |
| ATTRIBUTE RECORD |

Description in NTF
[POINTREC]
[GEOMETRY1]
[ATTREC]

Line feature

Each line feature is depicted by the use of the following records:

| | Description in NTF |
|-------------------------------------|--------------------|
| LINE RECORD | [LINEREC] |
| GEOMETRY RECORD | [GEOMETRY1] |
| GEOMETRY CONTINUATION RECORDS | |
| ATTRIBUTE RECORDS | [ATTREC] |

Geometry records

Geometry records contain the coordinate position(s) in metres of the feature. Point features contain one coordinate pair; line features contain two or more coordinate pairs. Geometry Continuation Records are used where required. {X_COORDS}, {Y_COORDS} and {QPLAN} are treated as separate fields.

Name detail

Each cartographically positioned name is depicted by the use of the following records:

| | Description in NTF |
|----------------------------|--------------------|
| TEXT RECORD | [TEXTREC] |
| TEXT POSITION RECORD | [TEXTPOS] |
| TEXT REPRESENTATION RECORD | [TEXTREP] |
| GEOMETRY RECORD | [GEOMETRY1] |
| ATTRIBUTE RECORD | [ATTREC] |

Records

Text details are only given when a name has been cartographically positioned. The [Attribute Record](#) [ATTREC] contains the definitive name and is pointed to by the [Text Record](#) [TEXTREC].

The Text Record [TEXTREC] points to the Attribute Record [ATTREC] and also points to the [Text Position Record](#) [TEXTPOS].

The Text Position Record [TEXTPOS] refers back to the Text Record [TEXTREC] and points to the Geometry Record [GEOMETRY 1] containing the coordinates of the digitised position. The Text Position Record [TEXTPOS] also points to the [Text Representation Record](#) [TEXTREP], which contains the standard digitising position and orientation of the text.

All other names are held as attributes only.

Node detail

Node feature

Each node feature is depicted by the use of the following records:

| | Description in NTF |
|--------------------------------|--------------------|
| NODE RECORD | [NODEREC] |
| NODE CONTINUATION RECORD | |
| GEOMETRY RECORD | [GEOMETRY1] |
| POINT RECORD | [POINTREC] |
| ATTRIBUTE RECORD | [ATTREC] |

All links in Meridian 2 terminate in explicit node records; each node is related to a point and its attributes via a common geometry record. This structure allows an attribute with a node within the constraints of NTF.

Records

[Node Record](#) [NODEREC] transfers details of the bearings and number of lines that meet at a point or node.

The Node Record [NODEREC] contains references to each [Line Record](#) [LINEREC] that meets at that node and to the [Geometry Record](#) [GEOMETRY 1]. The Geometry Record [GEOMETRY 1] is referenced by the [Point Records](#) [POINTREC] containing the feature attributes of the node.

Where lines do not meet at a previously specified point feature, a special point feature is created.

The [Node Record](#) [NODEREC] can contain details of up to five line features that meet at a node. Further lines meeting at that node are written to the Node Continuation Record.

It is important to note that, although the Node Record contains references to its appropriate point and line features, the point and line features do not contain references to the node.

Feature information relevant to NTF

Point features

Point features can exist independently and at the junction or ends of lines. The point feature gives a position and attribute to the corresponding node.

Line features

All line features, with the exception of where railways cross at different levels, are broken when they intersect one another within a layer.

NOTE: A layer is a subset of digital map data, selected on a basis other than position. For example, one layer might consist of all features relating to roads and another to railways.

The first and last coordinate pairs in a line correspond exactly with the start or end coordinates of any adjoining line(s).

A line cannot cross from one tile (10 km by 10 km square) to the next – it is split on the tile edge; see [Unique identifiers](#).

All linear features are continuous. Cartographic gaps are closed during the digitising process.

Coordinates

Coordinate values and the number of coordinate pairs in a feature are transferred in the [GEOMETRY1] NTF record.

All coordinates within the data are expressed as strings of five numeric characters. Leading zeros are present to complete the five characters.

All coordinates are measured from the local origin, which is the south-west corner of the tile.

To convert coordinate data to full National Grid coordinates, add the coordinates of the feature to those of the south-west corner of the tile. The south-west corner coordinates are contained within the {X_ORIG} and {Y_ORIG} fields of the [Section Header Record](#) ([SECHREC] '07').

Bearings

Bearings are transferred in the {ORIENT} field of the [Node Record](#) [NODEREC].

Bearings are National Grid bearings, in degrees, measured clockwise from grid north.

The start of line bearing, indicated by a value of 1 in the {DIR} field of the Node Record [NODEREC], is the bearing of the first segment of the line. The direction is from the start of the line to the next pair of coordinates or, if there are only two coordinate pairs, from the start to the end of the line.

The end of line bearing, indicated by a 2 in the {DIR} field, is the bearing of the last segment of the line. The direction is from the end of the feature to the last-minus-one pair of coordinates.

Attribute codes

Attribute codes provide supplementary information on a feature, providing such qualifying information as feature code, feature name, orientation and so on.

In NTF, the structure of user-defined attributes is described in the [Attribute Description Record](#) [ATTDESC].

The actual attribute detail of a record is written in the [Attribute Record](#) [ATTREC].

Attributes, which are used in the supply of Meridian 2 data, are:

- FC **Feature code** – contains the numeric feature code of the feature.
- OD **OSODR** – a unique identifier for links and nodes on road features.
- LL **Length of link.**
- RN **Road number** – DfT route number.
- TR **Trunk road** indicator.
- RT **Roundabout** indicator.
- JN **Junction name** – the name of a road junction.
- LC **Left county** boundary indicator.
- RC **Right county** boundary indicator.
- LD **Left district*** boundary indicator.
- RD **Right district*** boundary indicator.
- PI **Global ID** – a unique identifier for administrative areas.
- DA **DLUA ID** – a unique identifier for a developed land use areas.
- PN **Proper name** – the definitive name for a developed land use area or railway station.
- RI **Rail ID** – a unique railway link identifier.
- SN **Settlement name** text.
- SI **Station ID** – a unique railway station identifier.
- NM **Admin name** – an administrative area name.
- TX **Text** – independent text.
- FA **Forest ID** – a unique identifier for forest areas.
- WA **Water area** – a unique identifier for water area.
- WI **Water link** – a unique identifier for water links.
- HT **Height ID** – a unique identifier for gridded height.

* Includes London borough and unitary authority area.

Unique identifiers

Unique identifiers are used to uniquely identify some features within Meridian 2. These are:

- **Ordnance Survey Roads Database Reference (OSODR)** – this uniquely identifies any road link or road node within the national ROADS database and is therefore compatible with the OSCAR family of products. Interchange of data between Meridian 2 and OSCAR is possible with software modification.
- **Railway and railway station identifiers** – these uniquely identify any railway link or railway station within the national Meridian 2 database.
- **Developed land use area identifier** – this uniquely identifies any developed land use area seed point within the national Meridian 2 database.
- **Global identifier** – this uniquely identifies any administrative area seed point within the 10 km by 10 km tile.
- **Water identifier** – this uniquely identifies the hydrology (inland water) seed.
- **Woodland identifier** – this uniquely identifies the woodland seed.

The unique identifiers are unique references and are maintained, except where there has been significant change to a feature.

The unique identifier may refer to several links representing a linear object across tiles, for example, a road or a railway, which may be chained together across tile edges. Thus, on adjoining tiles there may be two or more links with the same unique identifier, see [figure 6.1](#) and [figure 6.2](#).

Record IDs

The identifying fields for each NTF record, for example, NODE_ID for [NODEREC], LINE_ID for [LINEREC] and so on, are unique within each individual section (tile) supplied. They are not maintained between supplies.

Figure 6.1: Example of a unique identifier – OSODR

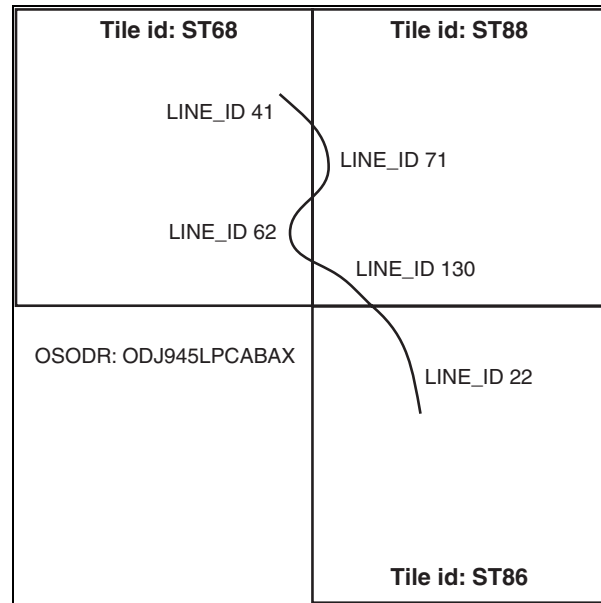
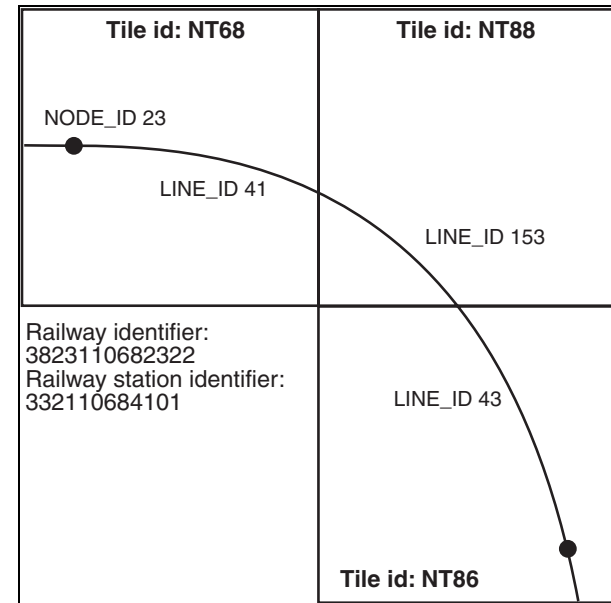

Figure 6.2: Example of unique identifier – a railway and railway station



Feature layers

This section contains a list of all the valid features used with Meridian 2. The list contains a description of each feature, its feature type, its feature code (FC) and a list of the attributes, other than FC, which can be associated with that feature. The list is segmented by feature layer.

NOTE: All features carry the attribute FC as the feature code.

Roads

| Feature description | Type | Code | Attribute(s) |
|---------------------|-------|------|--------------------------------|
| Motorway | Line | 3000 | FC, LL, NP, OD, PO, RN, TR, PN |
| A road | Line | 3001 | FC, LL, NP, OD, PO, RN, TR, PN |
| B road | Line | 3002 | FC, LL, NP, OD, PO, RN, TR, PN |
| Minor road | Line | 3004 | FC, LL, NP, OD, PO, RN, TR, PN |
| Road node | Point | 3500 | FC, NP, OD, PO, JN, RT, SN |
| Road edge node | Point | 3501 | FC, NP, OD, PO, JN, RT, SN |

Railways

| Feature description | Type | Code | Attribute(s) |
|---------------------|-------|------|--------------|
| Railway | Line | 6140 | FC, RI |
| Tunnelled railway | Line | 6142 | FC, RI |
| Railway station | Point | 6155 | FC, SI, PN |
| Railway node | Point | 6730 | FC |
| Railway edge node | Point | 6731 | FC |

Administrative areas and coastline

| Feature description | Type | Code | Attribute(s) |
|---------------------------|-------|------|--------------------|
| County boundary | Line | 6401 | FC, LC, RC |
| District* boundary | Line | 6403 | FC, LD, RD |
| County/district* boundary | Line | 6405 | FC, LC, RC, LD, RD |
| Neat line | Line | 6800 | FC, LC, RC, LD, RD |
| County seed | Point | 6411 | FC, PI, NM |
| District* seed | Point | 6415 | FC, PI, NM |
| Boundary node | Point | 6710 | FC |
| Boundary edge node | Point | 6711 | FC |
| Coastline | Line | 6200 | FC, LC, RC, LD, RD |
| Coastline node | Point | 6740 | FC |
| Coastline edge node | Point | 6741 | FC |

Developed land use areas (DLUA)

| Feature description | Type | Code | Attribute(s) |
|---------------------|-------|------|--------------|
| DLUA boundary | Line | 6300 | FC |
| DLUA seed | Point | 6310 | FC, PN, DA |
| DLUA node | Point | 6720 | FC |
| DLUA edge node | Point | 6721 | FC |
| Neat line | Line | 6801 | FC |

Cartographic names

| Feature description | Type | Code | Attribute(s) |
|---------------------|-------|------|--------------|
| Place name | Point | 6500 | FC, TX |
| Station name | Point | 6551 | FC, TX |

*NOTE: * Includes London borough and unitary authority areas.*

Hydrology

| Feature description | Type | Code | Attribute(s) |
|----------------------------|-------|------|--------------|
| Water feature river small | Line | 6223 | FC, WI, PN |
| Water feature river medium | Line | 6224 | FC, WI, PN |
| Water feature river large | Line | 6225 | FC, WI, PN |
| Water feature hidden water | Line | 6230 | FC, WI, PN |
| Water feature aqueduct | Line | 6231 | FC, WI, PN |
| Water feature dark link | Line | 6232 | FC, WI, PN |
| Water feature canal | Line | 6243 | FC, WI, PN |
| Water feature lake | Line | 6255 | FC, WI, PN |
| Area water seed | Point | 6292 | FC, WA |
| Water text | Point | 6552 | FC, TX |
| Water feature node | Point | 6770 | FC |
| Area water node | Point | 6771 | FC |
| Area water edge node | Point | 6772 | FC |
| Water feature edge node | Point | 6773 | FC |
| Area water neat line | Line | 6803 | FC |

Woodlands

| Feature description | Type | Code | Attribute(s) |
|---------------------|-------|------|--------------|
| Woodland boundary | Line | 6664 | FC |
| Woodland seed | Point | 6663 | FC, FA, |
| Woodland node | Point | 6750 | FC |
| Woodland edge node | Point | 6751 | FC |
| Woodland neat line | Line | 6802 | FC |

Height

| Feature description | Type | Code | Attribute(s) |
|---------------------|-------|------|--------------|
| Gridded height | Point | 6762 | FC, HT |

Chapter 7 Record structures for the transfer of Meridian 2 in NTF

NTF Record List

This list comprises the valid record types used in the Meridian 2 NTF transfer set.

| Descriptor | Description | Record name |
|------------|--|-------------|
| 01 | Volume Header Record – defines the donor and data type. | [VOLHDREC] |
| 02 | Database Header Record – transfers data about the database. | [DBHREC] |
| 05 | Feature Classification Record – defines data classifications. | [FEATCLASS] |
| 07 | Section Header Record – defines coordinate and structure types, unit scale, factors and so on. | [SECHREC] |
| 14 | Attribute Record – defines the attributes for line and point records. | [ATTREC] |
| 15 | Point Record – identifies the definition of node points. | [POINTREC] |
| 16 | Node Record – defines the topological relationship between links and nodes. | [NODEREC] |
| 21 | Two-dimensional Geometry Record – defines the two-dimensional geometry for a link or node. | [GEOMETRY1] |
| 23 | Line Record – identifies the definition of a link. | [LINEREC] |
| 40 | Attribute Description Record – defines attribute descriptions and their fields. | [ATTDESC] |
| 43 | Text Record – identifies the Text Position Record and Attribute Record. | [TEXTREC] |
| 44 | Text Position Record – identifies the Text Representation Record and Geometry Record. | [TEXTPOS] |
| 45 | Text Representation Record – defines the font, text height and digitised position. | [TEXTREP] |
| 90 | Comment Record – transfers change information or information about empty tiles. | [COMMENT] |
| 99 | Volume Terminator Record – defines the end of the transfer set. | [VOLTERM] |

NOTE: Where Meridian 2 height differs from Meridian 2 full dataset, a record example will be shown.

Volume Header Record [VOLHDREC] 01

| Field | Position | Format | Value example | Description |
|-----------|----------|--------|---------------------|---|
| REC_DESC | 01:02 | A2 | 01 | |
| DONOR | 03:22 | A20 | ORDNANCE SURVEY<5S> | |
| RECIPIENT | 23:42 | A20 | <20S> | Not used. |
| TRANDATE | 43:50 | DATE | yyyymmdd | Supply date. |
| SERIAL | 51:54 | I4 | 0000 | Not used. |
| VOLNUM | 55:56 | I2 | nn | Volume number 01 to 99. |
| NTFLEVEL | 57:57 | I1 | 3 | NTF Level 3. |
| NTFVER | 58:61 | R4.2 | 0200 | NTF Version 2.0. |
| NTFOR | 62:62 | A1 | V | Variable length records. |
| EOR | 63:63 | A1 | % or <S> | Sets [EOR] to % on formatted media or default % for formatted media. |
| DIVIDER | 64:64 | A1 | \ | Divider used to terminate variable length text fields. |
| CONT_MARK | 65:65 | I1 | 0 | No further records. |
| EOR | 66:66 | A1 | % | Record terminator. |

Record example:

| | | | | | | | | | | | | | | | | | | | |
|-------------------|---|---|---|---|---|---|---|---|---|--------------------------|---|---|---|---|---|---|---|---|---|
| 01ORDNANCE SURVEY | | | | | | | | | | 2001121000000130200V \0% | | | | | | | | | |
| 1 | | 2 | | 3 | | 4 | | 5 | | 6 | | 7 | | 8 | | | | | |
| 1 | 2 | 3 | 4 | 5 | 6 | 7 | 8 | 9 | 0 | 1 | 2 | 3 | 4 | 5 | 6 | 7 | 8 | 9 | 0 |

Template

Database Header Record [DBHREC] 02

Record 1

| Field | Position | Format | Value example | Description |
|-----------|----------|--------|--------------------|---|
| REC_DESC | 01:02 | A2 | 02 | Record type identifier. |
| DBNAME | 03:22 | A20 | Meridian_02.01<6S> | Database name. |
| DDNAME | 23:42 | A20 | DEFAULT_02.00<7S> | Standard data dictionary name. |
| DDATE | 43:50 | DATE | 19920515 | Release date of NTF version being used. |
| DDBASE | 51:70 | A20 | <20S> | Not used. |
| DDBDATE | 71:78 | DATE | 00000000 | Not used. |
| CONT_MARK | 79:79 | I1 | 1 | Continuation record follows. |
| EOR | 80:80 | A1 | % | Record terminator. |

Record 2

| Field | Position | Format | Value example | Description |
|------------|----------|--------|--------------------|---------------------------------------|
| REC_DESC | 01:02 | A2 | 00 | |
| FCNAME | 03:22 | A20 | Meridian_02.00<6S> | Data specification (product version). |
| FCDATE | 23:30 | DATE | 20000901 | Date of data specification. |
| DQNAME | 31:50 | A20 | <20S> | Not used. |
| DQDATE | 51:58 | DATE | 00000000 | Not used. |
| DATA_MODEL | 59:60 | I2 | 00 | |
| CONT_MARK | 61:61 | I1 | 0 | No further records. |
| EOR | 62:62 | A1 | % | Record terminator. |

Record example:

```

02Meridian02.01           DEFAULT_02.00           19920515                               000000001%
00Meridian_02.00       20000901                               000000000000%

```

| | | | | | | | |
|---|---|---|---|---|---|---|---|
| 1 | 2 | 3 | 4 | 5 | 6 | 7 | 8 |
| 1 | 2 | 3 | 4 | 5 | 6 | 7 | 8 |
| 1 | 2 | 3 | 4 | 5 | 6 | 7 | 8 |
| 1 | 2 | 3 | 4 | 5 | 6 | 7 | 8 |

Template

Gridded height record example:

```
02Meridian2_ht_01.99  DEFAULT_02.00          19920515          000000001%
00Meridian_02.00    20000901          000000000000%
```

| | | | | | | | | |
|---|---|---|---|---|---|---|---|---|
| | 1 | 2 | 3 | 4 | 5 | 6 | 7 | 8 |
| 1 | 2 | 3 | 4 | 5 | 6 | 7 | 8 | 9 |
| 0 | 1 | 2 | 3 | 4 | 5 | 6 | 7 | 8 |
| 2 | 3 | 4 | 5 | 6 | 7 | 8 | 9 | 0 |
| 3 | 4 | 5 | 6 | 7 | 8 | 9 | 0 | 1 |
| 4 | 5 | 6 | 7 | 8 | 9 | 0 | 1 | 2 |
| 5 | 6 | 7 | 8 | 9 | 0 | 1 | 2 | 3 |
| 6 | 7 | 8 | 9 | 0 | 1 | 2 | 3 | 4 |
| 7 | 8 | 9 | 0 | 1 | 2 | 3 | 4 | 5 |
| 8 | 9 | 0 | 1 | 2 | 3 | 4 | 5 | 6 |
| 9 | 0 | 1 | 2 | 3 | 4 | 5 | 6 | 7 |

Template

Feature Classification Record [FEATCLASS] 05

| Field | Position | Format | Value example | Description |
|-----------|----------|--------|---------------|---------------------------------------|
| REC_DESC | 01:02 | A2 | 05 | |
| FEAT_CODE | 03:06 | I4 | | Contains four-character feature code. |
| CODE_COM | 07:16 | A10 | <10S> | Not used. |
| STCLASS | 17:36 | A20 | <20S> | Not used. |
| FEATDES | 37:* | A* | | Feature description. |
| DIVIDER | *.* | A1 | \ | Divider. |
| CONT_MARK | *.* | I1 | 0 | No further records. |
| EOR | *.* | A1 | % | Record terminator. |

* = variable integer

Record example:

```
053000          Motorway\0%
```

| | | | | | | | | |
|---|---|---|---|---|---|---|---|---|
| | 1 | 2 | 3 | 4 | 5 | 6 | 7 | 8 |
| 1 | 2 | 3 | 4 | 5 | 6 | 7 | 8 | 9 |
| 0 | 1 | 2 | 3 | 4 | 5 | 6 | 7 | 8 |
| 2 | 3 | 4 | 5 | 6 | 7 | 8 | 9 | 0 |
| 3 | 4 | 5 | 6 | 7 | 8 | 9 | 0 | 1 |
| 4 | 5 | 6 | 7 | 8 | 9 | 0 | 1 | 2 |
| 5 | 6 | 7 | 8 | 9 | 0 | 1 | 2 | 3 |
| 6 | 7 | 8 | 9 | 0 | 1 | 2 | 3 | 4 |
| 7 | 8 | 9 | 0 | 1 | 2 | 3 | 4 | 5 |
| 8 | 9 | 0 | 1 | 2 | 3 | 4 | 5 | 6 |
| 9 | 0 | 1 | 2 | 3 | 4 | 5 | 6 | 7 |

Template

Section Header Record [SECHREC] 07

Record 1

| Field | Position | Format | Value example | Description |
|------------|----------|--------|---------------|---|
| REC_DESC | 01:02 | A2 | 07 | |
| SECT_REF | 03:12 | A10 | | 10 km by 10 km tile reference, for example, TQ24<6S>. |
| COORD_TYP | 13:13 | I1 | 2 | Rectangular. |
| STRUCT_TYP | 14:14 | I1 | 1 | Vector. |
| XYLEN | 15:19 | I5 | 00005 | Five-character coordinate fields (to 1 metre). |
| XY_UNIT | 20:20 | I1 | 2 | Metres. |
| XY_MULT | 21:30 | R10.3 | 0000001000 | Default. |
| ZLEN | 31:35 | I5 | 00000 | Not used. |
| Z_UNIT | 36:36 | I1 | 0 | Not used. |
| Z_MULT | 37:46 | R10.3 | 0000001000 | Not used. |
| X_ORIG | 47:56 | I10 | | X coordinates of south-west corner of unit. |
| Y_ORIG | 57:66 | I10 | | Y coordinates of south-west corner of unit. |
| Z_DATUM | 67:76 | I10 | 0000000000 | Not used. |
| CONT_MARK | 77:77 | I1 | 1 | Continuation record follows. |
| EOR | 78:78 | A1 | % | Record terminator. |

Record 2

| Field | Position | Format | Value example | Description |
|-----------|----------|--------|---------------|---------------------|
| REC_DESC | 01:02 | A2 | 00 | |
| XMIN | 03:12 | I10 | 0000000000 | |
| YMIN | 13:22 | I10 | 0000000000 | |
| XMAX | 23:32 | I10 | 0000010000 | |
| YMAX | 33:42 | I10 | 0000010000 | |
| XY_ACC | 43:47 | R5.2 | 00000 | Not used. |
| Z_ACC | 48:52 | R5.2 | 00000 | Not used. |
| SURV_DATE | 53:60 | DATE | 00000000 | Not used. |
| LAST_AMND | 61:68 | DATE | yyyymmdd | Date last amended. |
| COPYRIGHT | 69:76 | DATE | yyyymmdd | Copyright date. |
| CONT_MARK | 77:77 | I1 | 0 | No further records. |
| EOR | 78:78 | A1 | % | Record terminator. |

Record example:

07TQ24 21000052000000100000000000000010000000520000000014000000000000001%
00000000000000000000000000000000100000000001000000000000000000000020011210200112100%

| | 1 | 2 | 3 | 4 | 5 | 6 | 7 | 8 |
|------------|------------|------------|------------|------------|------------|------------|------------|------------|
| 1234567890 | 1234567890 | 1234567890 | 1234567890 | 1234567890 | 1234567890 | 1234567890 | 1234567890 | 1234567890 |

Template

NOTE 1: Last amend date will not be used for Mer_2_rds.

Attribute Record [ATTREC] 14 for road links

| Field | Position | Format | Value example | Description |
|-----------|----------|--------|---------------|-----------------------------|
| REC_DESC | 01:02 | A2 | 14 | |
| ATT_ID | 03:08 | I6 | | Unique ID for record. |
| VAL_TYPE | 09:10 | A2 | OD | |
| VALUE | 11:23 | A13 | | Unique ID (OSODR) for link. |
| VAL_TYPE | 24:25 | A2 | FC | |
| VALUE | 26:29 | I4 | | Feature code. |
| VAL_TYPE | 30:31 | A2 | LL | |
| VALUE | 32:33 | I5 | | Length of link. |
| VAL_TYPE | **.* | A2 | PN | |
| VALUE | **.* | A* | | Road name. |
| DIVIDER | **.* | A1 | \ | |
| VAL_TYPE | **.* | A2 | RN | |
| VALUE | **.* | A* | | Road number. |
| DIVIDER | **.* | A1 | \ | |
| VAL_TYPE | **.* | A2 | TR | |
| VALUE | **.* | A1 | Y | Trunk road indicator. |
| CONT_MARK | **.* | I1 | 0 | No further records. |
| | | | or 1 | Continuation record. |
| EOR | **.* | A1 | % | Record terminator. |

* = variable integer.

Record example:

```
14000001ODO338UHK0PLWAXFC3001LL00342PNCOMMERCIAL STREET\NP02POO1J945LPCABAXPO1%
0001CB3HJ50VFWARNA315 (T) \TRY0%
```

| | 1 | 2 | 3 | 4 | 5 | 6 | 7 | 8 |
|----|----|----|----|----|----|----|----|----|
| 1 | 2 | 3 | 4 | 5 | 6 | 7 | 8 | 9 |
| 10 | 11 | 12 | 13 | 14 | 15 | 16 | 17 | 18 |
| 19 | 20 | 21 | 22 | 23 | 24 | 25 | 26 | 27 |
| 28 | 29 | 30 | 31 | 32 | 33 | 34 | 35 | 36 |
| 37 | 38 | 39 | 40 | 41 | 42 | 43 | 44 | 45 |
| 46 | 47 | 48 | 49 | 50 | 51 | 52 | 53 | 54 |
| 55 | 56 | 57 | 58 | 59 | 60 | 61 | 62 | 63 |
| 64 | 65 | 66 | 67 | 68 | 69 | 70 | 71 | 72 |
| 73 | 74 | 75 | 76 | 77 | 78 | 79 | 80 | 81 |
| 82 | 83 | 84 | 85 | 86 | 87 | 88 | 89 | 90 |

Template

NOTE 1: PN, RN and TR records will only be included where a name exists. 2: Continuation records may be necessary to specify the number of Parent OSODRs (PO).

Attribute Record [ATTREC] 14 for road nodes

| Field | Position | Format | Value example | Description |
|------------|----------|--------|---------------|-----------------------------|
| REC_DESC | 01:02 | A2 | 14 | |
| ATT_ID | 03:08 | I6 | | Unique ID for record. |
| VAL_TYPE | 09:10 | A2 | OD | |
| VALUE | 11:23 | A13 | | Unique ID (OSODR) for node. |
| VAL_TYPE | 24:25 | A2 | FC | |
| VALUE | 26:29 | I4 | | Feature code. |
| VAL_TYPE | ** | A2 | JN | |
| VALUE | ** | A* | | Junction name. |
| DIVIDER | ** | A1 | \ | |
| VAL_TYPE | ** | A2 | SN | |
| VALUE | ** | A* | | Settlement name. |
| DIVIDER | ** | A1 | \ | |
| VALUE TYPE | ** | A2 | RT | |
| VALUE | ** | A1 | Y | Roundabout. |
| CONT_MARK | ** | I1 | 0 | No further records. |
| | | | or 1 | Continuation record. |
| EOR | ** | A1 | % | Record terminator. |

* = variable integer.

Record example:

```
14000023ODO3DF42CK0VTEGFC3500NP03POO1J945LPCABATPOO142WFUP80AA0POO1CV33LKPCBXE1%
00JNM27 J2\SNSOUTHAMPTON\RTY0%
```

| | 1 | 2 | 3 | 4 | 5 | 6 | 7 | 8 |
|--|---|---|---|---|---|---|---|---|
| 1234567890123456789012345678901234567890123456789012345678901234567890 | | | | | | | | |

Template

NOTE 1: JN, SN and RT records will only be included where a name exists. 2: Continuation records may be necessary to specify the number of Parent OSODRs (PO).

Attribute Record [ATTREC] 14 for administrative area links (county, district, coastline and neat line)

| Field | Position | Format | Value example | Description |
|-----------|----------|--------|---------------|--|
| REC_DESC | 01:02 | A2 | 14 | |
| ATT_ID | 03:08 | I6 | | Unique attribute record identifier. |
| VAL_TYPE | 09:10 | A2 | FC | |
| VALUE | 11:14 | I4 | | Feature code. |
| AL_TYPE | 15:16 | A2 | LC | |
| VALUE | 17:22 | I6 | | Left county pointer to seed (optional). |
| AL_TYPE | 23:24 | A2 | RC | |
| VALUE | 25:30 | I6 | | Right county pointer to seed (optional). |
| VAL_TYPE | 31:32 | A2 | LD | |
| VALUE | 33:38 | I6 | | Left district pointer to seed (optional). |
| AL_TYPE | 39:40 | A2 | RD | |
| VALUE | 41:46 | I6 | | Right district pointer to seed (optional). |
| CONT_MARK | 47:47 | I1 | 0 | No further records. |
| EOR | 48:48 | A1 | % | Record terminator. |

Record example:

14000014FC6405LC043050RC043084LD069234RD0697200%

| 1 | | | | | 2 | | | | | 3 | | | | | 4 | | | | | 5 | | | | | 6 | | | | | 7 | | | | | 8 | | | | | | | | | | | | | | |
|---|---|---|---|---|---|---|---|---|---|---|---|---|---|---|---|---|---|---|---|---|---|---|---|---|---|---|---|---|---|---|---|---|---|---|---|---|---|---|---|---|---|---|---|---|---|---|---|---|---|
| 1 | 2 | 3 | 4 | 5 | 6 | 7 | 8 | 9 | 0 | 1 | 2 | 3 | 4 | 5 | 6 | 7 | 8 | 9 | 0 | 1 | 2 | 3 | 4 | 5 | 6 | 7 | 8 | 9 | 0 | 1 | 2 | 3 | 4 | 5 | 6 | 7 | 8 | 9 | 0 | 1 | 2 | 3 | 4 | 5 | 6 | 7 | 8 | 9 | 0 |

Template

Attribute Record [ATTREC] 14 for administrative area points and/or seeds

| Field | Position | Format | Value example | Description |
|-----------|----------|--------|---------------|---|
| REC_DESC | 01:02 | A2 | 14 | |
| ATT_ID | 03:08 | I6 | | Unique attribute record identifier. |
| VAL_TYPE | 09:10 | A2 | FC | |
| VALUE | 11:14 | I4 | | Feature code. |
| VAL_TYPE | 15:16 | A2 | PI | |
| VALUE | 17:22 | I6 | | Unique global (seed) identifier. |
| VAL_TYPE | 23:24 | A2 | NM | |
| VALUE | 25:* | A* | | Administrative area name. |
| DIVIDER | *.* | A1 | \ | Divider. |
| CONT_MARK | *.* | I1 | 0 or 1 | No further records or continuation record follows. |
| EOR | *.* | A1 | % | Record terminator. |

NOTE: * = variable integer.

Record example:

14000032FC6411PI043050NMHAMPSHIRE COUNTY\0%

| | 1 | 2 | 3 | 4 | 5 | 6 | 7 | 8 |
|---|---|---|---|---|---|---|---|---|
| 1 | 2 | 3 | 4 | 5 | 6 | 7 | 8 | 9 |
| 0 | 1 | 2 | 3 | 4 | 5 | 6 | 7 | 8 |
| 9 | 0 | 1 | 2 | 3 | 4 | 5 | 6 | 7 |
| 8 | 9 | 0 | 1 | 2 | 3 | 4 | 5 | 6 |
| 7 | 8 | 9 | 0 | 1 | 2 | 3 | 4 | 5 |
| 6 | 7 | 8 | 9 | 0 | 1 | 2 | 3 | 4 |
| 5 | 6 | 7 | 8 | 9 | 0 | 1 | 2 | 3 |
| 4 | 5 | 6 | 7 | 8 | 9 | 0 | 1 | 2 |
| 3 | 4 | 5 | 6 | 7 | 8 | 9 | 0 | 1 |
| 2 | 3 | 4 | 5 | 6 | 7 | 8 | 9 | 0 |
| 1 | 2 | 3 | 4 | 5 | 6 | 7 | 8 | 9 |
| 0 | 1 | 2 | 3 | 4 | 5 | 6 | 7 | 8 |

Template

Attribute Record [ATTREC] 14 for nodes (administrative areas, developed land use area, coastline and railway, hydrology and woodlands) and/or edge nodes (all layers)

| Field | Position | Format | Value example | Description |
|-----------|----------|--------|---------------|-------------------------------------|
| REC_DESC | 01:02 | A2 | 14 | |
| ATT_ID | 03:08 | I6 | | Unique attribute record identifier. |
| VAL_TYPE | 09:10 | A2 | FC | |
| VALUE | 11:14 | I4 | | Feature code. |
| CONT_MARK | 15:15 | I1 | 0 | No further records. |
| EOR | 16:16 | A1 | % | Record terminator. |

Attribute Record [ATTREC] 14 for developed land use area links

| Field | Position | Format | Value example | Description |
|-----------|----------|--------|---------------|-------------------------------------|
| REC_DESC | 01:02 | A2 | 14 | |
| ATT_ID | 03:08 | I6 | | Unique attribute record identifier. |
| VAL_TYPE | 09:10 | A2 | FC | |
| VALUE | 11:14 | I4 | | Feature code. |
| CONT_MARK | 15:15 | I1 | 0 | No further records. |
| EOR | 16:16 | A1 | % | Record terminator. |

Attribute Record [ATTREC] 14 for developed land use area points and/or seeds

| Field | Position | Format | Value example | Description |
|-----------|----------|--------|---------------|---|
| REC_DESC | 01:02 | A2 | 14 | |
| ATT_ID | 03:08 | I6 | | Unique attribute record identifier. |
| VAL_TYPE | 09:10 | A2 | FC | |
| VALUE | 11:14 | I4 | | Feature code. |
| VAL_TYPE | 15:16 | A2 | DA | |
| VALUE | 17:29 | A13 | | Unique developed land use area (seed) identifier. |
| VAL_TYPE | 30:31 | A2 | PN | |
| VALUE | 32:* | A* | | Developed land use area name. |
| DIVIDER | *.* | A1 | \ | Divider. |
| CONT_MARK | *.* | I1 | 0 or 1 | No further records or continuation record follows. |
| EOR | *.* | A1 | % | Record terminator. |

NOTE: * = variable

Record example:

14000032FC6310DA4418200463301PNGrafton\0%

| 1 | | | | | | | | | | 2 | | | | | | | | | | 3 | | | | | | | | | | 4 | | | | | | | | | | 5 | | | | | | | | | | 6 | | | | | | | | | | 7 | | | | | | | | | | 8 | | | | | | | | | | | | | | | | | | | | | | | | | | | | | | | | | | | | | | | |
|---|---|---|---|---|---|---|---|---|---|---|---|---|---|---|---|---|---|---|---|---|---|---|---|---|---|---|---|---|---|---|---|---|---|---|---|---|---|---|---|---|---|---|---|---|---|---|---|---|---|---|---|---|---|---|---|---|---|---|---|---|---|---|---|---|---|---|---|---|---|---|---|---|---|---|---|---|---|---|---|---|---|---|---|---|---|---|---|---|---|---|---|---|---|---|---|---|---|---|---|---|---|---|---|---|---|---|---|---|---|
| 1 | 2 | 3 | 4 | 5 | 6 | 7 | 8 | 9 | 0 | 1 | 2 | 3 | 4 | 5 | 6 | 7 | 8 | 9 | 0 | 1 | 2 | 3 | 4 | 5 | 6 | 7 | 8 | 9 | 0 | 1 | 2 | 3 | 4 | 5 | 6 | 7 | 8 | 9 | 0 | 1 | 2 | 3 | 4 | 5 | 6 | 7 | 8 | 9 | 0 | 1 | 2 | 3 | 4 | 5 | 6 | 7 | 8 | 9 | 0 | 1 | 2 | 3 | 4 | 5 | 6 | 7 | 8 | 9 | 0 | 1 | 2 | 3 | 4 | 5 | 6 | 7 | 8 | 9 | 0 | 1 | 2 | 3 | 4 | 5 | 6 | 7 | 8 | 9 | 0 | 1 | 2 | 3 | 4 | 5 | 6 | 7 | 8 | 9 | 0 | 1 | 2 | 3 | 4 | 5 | 6 | 7 | 8 | 9 | 0 |

Template

Attribute Record [ATTREC] 14 for cartographic name text

| Field | Position | Format | Value example | Description |
|-----------|----------|--------|----------------|---|
| REC_DESC | 01:02 | A2 | 14 | |
| ATT_ID | 03:08 | I6 | | Unique attribute record identifier. |
| VAL_TYPE | 09:10 | A2 | FC | |
| VALUE | 11:14 | I4 | | Feature code. |
| VAL_TYPE | 15:16 | A2 | TX | |
| VALUE | 17:* | A* | | Text string. |
| DIVIDER | **.: | A1 | \ | Divider. |
| CONT_MARK | **.: | I1 | 0 or 1 or 1 | No further records or continuation record follows. |
| EOR | **.: | A1 | % | Record terminator. |

NOTE: * = variable

Record example:

14000012FC6500TXANDOVER\0%

| | 1 | 2 | 3 | 4 | 5 | 6 | 7 | 8 |
|---|---|---|---|---|---|---|---|---|
| 1 | 2 | 3 | 4 | 5 | 6 | 7 | 8 | 9 |
| 0 | 1 | 2 | 3 | 4 | 5 | 6 | 7 | 8 |
| 9 | 0 | 1 | 2 | 3 | 4 | 5 | 6 | 7 |
| 8 | 9 | 0 | 1 | 2 | 3 | 4 | 5 | 6 |
| 7 | 8 | 9 | 0 | 1 | 2 | 3 | 4 | 5 |
| 6 | 7 | 8 | 9 | 0 | 1 | 2 | 3 | 4 |
| 5 | 6 | 7 | 8 | 9 | 0 | 1 | 2 | 3 |
| 4 | 5 | 6 | 7 | 8 | 9 | 0 | 1 | 2 |
| 3 | 4 | 5 | 6 | 7 | 8 | 9 | 0 | 1 |
| 2 | 3 | 4 | 5 | 6 | 7 | 8 | 9 | 0 |
| 1 | 2 | 3 | 4 | 5 | 6 | 7 | 8 | 9 |
| 0 | 1 | 2 | 3 | 4 | 5 | 6 | 7 | 8 |

Template

Attribute Record [ATTREC] 14 for railway links

| Field | Position | Format | Value example | Description |
|-----------|----------|--------|---------------|-------------------------------------|
| REC_DESC | 01:02 | A2 | 14 | |
| ATT_ID | 03:08 | I6 | | Unique attribute record identifier. |
| VAL_TYPE | 09:10 | A2 | FC | |
| VALUE | 11:14 | I4 | | Feature code. |
| VAL_TYPE | 15:16 | A2 | RI | |
| VALUE | 17:29 | A13 | | Unique railway link identifier. |
| CONT_MARK | 30:30 | I1 | 0 | No further records. |
| EOR | 31:31 | A1 | % | Record terminator. |

Record example:

14000002FC6140RI41842002735110%

| | 1 | 2 | 3 | 4 | 5 | 6 | 7 | 8 |
|--|---|---|---|---|---|---|---|---|
| 12345678901234567890123456789012345678901234567890123456789012345678901234567890 | | | | | | | | |

Template

Attribute Record [ATTREC] 14 for railway station nodes

| Field | Position | Format | Value example | Description |
|-----------|----------|--------|---------------|---|
| REC_DESC | 01:02 | A2 | 14 | |
| ATT_ID | 03:08 | I6 | | Unique attribute record identifier. |
| VAL_TYPE | 09:10 | A2 | FC | |
| VALUE | 11:14 | I4 | | Feature code. |
| VAL_TYPE | 15:16 | A2 | SI | |
| VALUE | 17:29 | A13 | | Unique railway station identifier. |
| VAL_TYPE | 30:31 | A2 | PN | |
| VALUE | 32:* | A* | | Station name. |
| DIVIDER | *.* | A1 | \ | Divider. |
| CONT_MARK | *.* | I1 | 0 or 1 | No further records or continuation record follows. |
| EOR | *.* | A1 | % | Record terminator. |

NOTE: * = variable integer.

Record example:

14000003FC6155SI4169010274901PNSandling Station\0%

| | 1 | 2 | 3 | 4 | 5 | 6 | 7 | 8 |
|--|---|---|---|---|---|---|---|---|
| 12345678901234567890123456789012345678901234567890123456789012345678901234567890 | | | | | | | | |

Template

Attribute Record [ATTREC] 14 for water feature (river, small)

| Field | Position | Format | Value example | Description |
|-----------|----------|--------|---------------|---|
| REC_DESC | 01:02 | A2 | 14 | |
| ATT_ID | 03:08 | I6 | | Unique attribute record identifier. |
| VAL_TYPE | 09:10 | A2 | FC | |
| VALUE | 11:14 | I4 | | Feature code. |
| VAL_TYPE | 15:16 | A2 | WI | |
| VALUE | 17:29 | A13 | | Unique water feature identifier. |
| VAL_TYPE | 30:31 | A2 | PN | |
| VALUE | 32:* | A* | | River name (optional). |
| DIVIDER | *.* | A1 | \ | Divider. |
| CONT_MARK | *.* | I1 | 0 or 1 | No further records or continuation record follows. |
| EOR | *.* | A1 | % | Record terminator. |

NOTE: * = variable integer.

Record example:

14000003FC6223WI6169050279090PNRiver Lydden\0%

| | 1 | 2 | 3 | 4 | 5 | 6 | 7 | 8 |
|---|---|---|---|---|---|---|---|---|
| 1 | 2 | 3 | 4 | 5 | 6 | 7 | 8 | 9 |
| 0 | 1 | 2 | 3 | 4 | 5 | 6 | 7 | 8 |
| 0 | 1 | 2 | 3 | 4 | 5 | 6 | 7 | 8 |
| 0 | 1 | 2 | 3 | 4 | 5 | 6 | 7 | 8 |
| 0 | 1 | 2 | 3 | 4 | 5 | 6 | 7 | 8 |

Template

NOTE: The WI identifier in the record example is fictional and does not relate to River Lydden.

Attribute Record [ATTREC] 14 for water area seeds

| Field | Position | Format | Value example | Description |
|-----------|----------|--------|---------------|---|
| REC_DESC | 01:02 | A2 | 14 | |
| ATT_ID | 03:08 | I6 | | Unique attribute record identifier. |
| VAL_TYPE | 09:10 | A2 | FC | |
| VALUE | 11:14 | I4 | | Feature code. |
| VAL_TYPE | 15:16 | A2 | WA | |
| VALUE | 17:29 | A13 | | Unique water area (seed) identifier |
| VAL_TYPE | 30:31 | A2 | PN | |
| VALUE | 32:* | A* | | Water area name (where applicable) |
| DIVIDER | *.* | A1 | \ | Divider. |
| CONT_MARK | *.* | I1 | 0 or 1 | No further records or continuation record follows. |
| EOR | *.* | A1 | % | Record terminator. |

NOTE: * = variable integer.

Record example:

14000032FC6292WA0060273530510PNULLSWATER\0%

| | 1 | 2 | 3 | 4 | 5 | 6 | 7 | 8 |
|---|---|---|---|---|---|---|---|---|
| 1 | 2 | 3 | 4 | 5 | 6 | 7 | 8 | 9 |
| 0 | 1 | 2 | 3 | 4 | 5 | 6 | 7 | 8 |
| 0 | 1 | 2 | 3 | 4 | 5 | 6 | 7 | 8 |
| 0 | 1 | 2 | 3 | 4 | 5 | 6 | 7 | 8 |
| 0 | 1 | 2 | 3 | 4 | 5 | 6 | 7 | 8 |
| 0 | 1 | 2 | 3 | 4 | 5 | 6 | 7 | 8 |
| 0 | 1 | 2 | 3 | 4 | 5 | 6 | 7 | 8 |
| 0 | 1 | 2 | 3 | 4 | 5 | 6 | 7 | 8 |
| 0 | 1 | 2 | 3 | 4 | 5 | 6 | 7 | 8 |
| 0 | 1 | 2 | 3 | 4 | 5 | 6 | 7 | 8 |

Template

NOTE: The WI identifier in the record example is fictional and does not relate to Ullswater.

Attribute Record [ATTREC] 14 for administrative area points and/or seeds

| Field | Position | Format | Value example | Description |
|-----------|----------|--------|---------------|---|
| REC_DESC | 01:02 | A2 | 14 | |
| ATT_ID | 03:08 | I6 | | Unique attribute record identifier. |
| VAL_TYPE | 09:10 | A2 | FC | |
| VALUE | 11:14 | I4 | | Feature code. |
| VAL_TYPE | 15:16 | A2 | PI | |
| VALUE | 17:22 | I6 | | Unique global (seed) identifier. |
| VAL_TYPE | 23:24 | A2 | NM | |
| VALUE | 25:* | A* | | Admin area name. |
| DIVIDER | *.* | A1 | \ | Divider. |
| CONT_MARK | *.* | I1 | 0 or 1 | No further records or continuation record follows. |
| EOR | *.* | A1 | % | Record terminator. |

NOTE: * = variable integer.

Record example:

14000032FC6411PI043050NMHAMPSHIRE COUNTY\0%

| | 1 | 2 | 3 | 4 | 5 | 6 | 7 | 8 |
|---|---|---|---|---|---|---|---|---|
| 1 | 2 | 3 | 4 | 5 | 6 | 7 | 8 | 9 |
| 0 | 1 | 2 | 3 | 4 | 5 | 6 | 7 | 8 |
| 9 | 0 | 1 | 2 | 3 | 4 | 5 | 6 | 7 |
| 8 | 9 | 0 | 1 | 2 | 3 | 4 | 5 | 6 |
| 7 | 8 | 9 | 0 | 1 | 2 | 3 | 4 | 5 |
| 6 | 7 | 8 | 9 | 0 | 1 | 2 | 3 | 4 |
| 5 | 6 | 7 | 8 | 9 | 0 | 1 | 2 | 3 |
| 4 | 5 | 6 | 7 | 8 | 9 | 0 | 1 | 2 |
| 3 | 4 | 5 | 6 | 7 | 8 | 9 | 0 | 1 |
| 2 | 3 | 4 | 5 | 6 | 7 | 8 | 9 | 0 |
| 1 | 2 | 3 | 4 | 5 | 6 | 7 | 8 | 9 |
| 0 | 1 | 2 | 3 | 4 | 5 | 6 | 7 | 8 |

Template

Attribute Record [ATTREC] 14 for gridded height point

| Field | Position | Format | Value example | Description |
|-----------|----------|--------|---------------|---|
| REC_DESC | 01:02 | A2 | 14 | |
| ATT_ID | 03:08 | I6 | | Unique attribute record identifier. |
| VAL_TYPE | 09:10 | A2 | FC | |
| VALUE | 11:14 | I4 | | Feature code. |
| VAL_TYPE | 15:16 | A2 | HT | |
| VALUE | 17:24 | I8 | | Height attribute. |
| CONT_MARK | 25:25 | I1 | 0 or 1 | No further records or continuation record follows. |
| EOR | 26:26 | A1 | % | Record terminator. |

NOTE: * = variable integer.

Record example:

14000090FC6762HT000000070%

| | 1 | 2 | 3 | 4 | 5 | 6 | 7 | 8 |
|--|---|---|---|---|---|---|---|---|
| 1234567890123456789012345678901234567890123456789012345678901234567890 | | | | | | | | |

Template

Point Feature Record [POINTREC] 15

| Field | Position | Format | Value example | Description |
|-----------|----------|--------|---------------|---------------------------------|
| REC_DESC | 01:02 | A2 | 15 | |
| POINT_ID | 03:08 | I6 | | Unique point record identifier. |
| GEOM_ID | 09:14 | I6 | | Pointer to [GEOMETRY1] record. |
| NUM_ATT | 15:16 | I2 | 01 | |
| ATT_ID | 17:22 | I6 | | Pointer to [ATTREC] record. |
| CONT_MARK | 23:23 | I1 | 0 | No further records. |
| EOR | 24:24 | A1 | % | Record terminator. |

Record example:

15000027004804010048040%

| | 1 | 2 | 3 | 4 | 5 | 6 | 7 | 8 |
|--|---|---|---|---|---|---|---|---|
| 12345678901234567890123456789012345678901234567890123456789012345678901234567890 | | | | | | | | |

Template

Node Record [NODEREC] 16

| Field | Position | Format | Value example | Description |
|-----------|----------|--------|----------------|---|
| REC_DESC | 01:02 | A2 | 16 | |
| NODE_ID | 03:08 | I6 | | Unique node record identifier. |
| GEOM_ID | 09:14 | I6 | | Pointer to [GEOMETRY1] record of point feature. |
| NUM_LINKS | 15:18 | I4 | >0 | |
| DIR | *.* | I1 | 1 or 2 | 1 for start of link or 2 for end of link. |
| GEOM_ID | *.* | I6 | | Pointer to [GEOMETRY1] of link. |
| ORIENT | *.* | R4,1 | | Bearing of first/last segment of link clockwise from grid north (not used for roads). |
| LEVEL | *.* | I1 | 0 or 1 | Link level at node (roads only). |
| CONT_MARK | *.* | I1 | 0 | Link level at node for all other layers. |
| EOR | *.* | A1 | 0 or 1 % | No further records or continuation record follows. Record terminator. |

NOTE: * = variable integer.

Record example:

1600000800480400012004921226000%

| | 1 | 2 | 3 | 4 | 5 | 6 | 7 | 8 |
|------------|------------|------------|------------|------------|------------|------------|------------|------------|
| 1234567890 | 1234567890 | 1234567890 | 1234567890 | 1234567890 | 1234567890 | 1234567890 | 1234567890 | 1234567890 |

Template

NOTES:

| indicates repeating group.

The pair of fields {VAL_TYPE} and {VALUE} will repeat to specify all the attributes required. It may be necessary to utilise a continuation record to specify all attributes.

Two-dimensional Geometry Record [GEOMETRY1] 21 associated with POINTREC

| Field | Position | Format | Value example | Description |
|-----------|----------|--------|---------------|------------------------------------|
| REC_DESC | 01:02 | A2 | 21 | |
| GEOM_ID | 03:08 | I6 | | Unique geometry record identifier. |
| GTYPE | 09:09 | I1 | 1 | Point feature. |
| NUM_COORD | 10:13 | I4 | 0001 | Point has one coordinate pair. |
| X_COORD | 14:18 | I5 | X coordinate | |
| Y_COORD | 19:23 | I5 | Y coordinate | |
| QPLAN | 24:24 | A1 | <S> | Not used. |
| CONT_MARK | 25:25 | I1 | 0 | No further records. |
| EOR | 26:26 | A1 | % | Record terminator. |

Record example:

21000031100011564044030 0%

| | 1 | 2 | 3 | 4 | 5 | 6 | 7 | 8 |
|--|---|---|---|---|---|---|---|---|
| 1234567890123456789012345678901234567890123456789012345678901234567890 | | | | | | | | |

Template

Two-dimensional Geometry Record [GEOMETRY1] 21 associated with LINEREC

| Field | Position | Format | Value example | Description |
|-----------|----------|--------|---------------|---|
| REC_DESC | 01:02 | A2 | 21 | |
| GEOM_ID | 03:08 | I6 | | Unique geometry record identifier. |
| GTYPE | 09:09 | I1 | 2 | Line feature. |
| NUM_COORD | 10:13 | I4 | | Number of coordinate pairs, in range 0002–9999. |
| X_COORD | 14:18 | I5 | X coordinate | Repeated until {NUM_COORD} has been transferred. |
| Y_COORD | 19:23 | I5 | Y coordinate | Repeated until {NUM_COORD} has been transferred. |
| QPLAN | 24:24 | A1 | <S> | Not used. |
| CONT_MARK | *.* | I1 | 0 or 1 | No further records or continuation record follows. |
| EOR | *.* | A1 | % | Record terminator. |

NOTES:

* = variable integer.

This record may contain many CONTINUATION 00 records.

| indicates a repeating group.

The pair of fields {VAL_TYPE} and {VALUE} will repeat to specify all the attributes required. It may be necessary to utilise a continuation record to specify all attributes.

Line Feature Record [LINEREC] 23

| Field | Position | Format | Value example | Description |
|-----------|----------|--------|---------------|--------------------------------|
| REC_DESC | 01:02 | A2 | 23 | |
| LINE_ID | 03:08 | I6 | | Unique line record identifier. |
| GEOM_ID | 09:14 | I6 | | Pointer to [GEOMETRY1] record. |
| NUM_ATT | 15:16 | I2 | 01 | |
| ATT_ID | 17:22 | I6 | | Pointer to [ATTREC] record. |
| CONT_MARK | 23:23 | I1 | 0 | No further records. |
| EOR | 24:24 | A1 | % | Record terminator. |

Record example:

23004804005369010053690%

| | 1 | 2 | 3 | 4 | 5 | 6 | 7 | 8 |
|---|---|---|---|---|---|---|---|---|
| 1 | 2 | 3 | 4 | 5 | 6 | 7 | 8 | 9 |
| 0 | 1 | 2 | 3 | 4 | 5 | 6 | 7 | 8 |
| 1 | 2 | 3 | 4 | 5 | 6 | 7 | 8 | 9 |
| 2 | 3 | 4 | 5 | 6 | 7 | 8 | 9 | 0 |
| 3 | 4 | 5 | 6 | 7 | 8 | 9 | 0 | 1 |
| 4 | 5 | 6 | 7 | 8 | 9 | 0 | 1 | 2 |
| 5 | 6 | 7 | 8 | 9 | 0 | 1 | 2 | 3 |
| 6 | 7 | 8 | 9 | 0 | 1 | 2 | 3 | 4 |
| 7 | 8 | 9 | 0 | 1 | 2 | 3 | 4 | 5 |
| 8 | 9 | 0 | 1 | 2 | 3 | 4 | 5 | 6 |
| 9 | 0 | 1 | 2 | 3 | 4 | 5 | 6 | 7 |
| 0 | 1 | 2 | 3 | 4 | 5 | 6 | 7 | 8 |

Template

Attribute Description Record [ATTDESC] 40

| Field | Position | Format | Value example | Description |
|-----------|----------|--------|-----------------------|-----------------------------|
| REC_DESC | 01:02 | A2 | 40 | |
| VAL_TYPE | 03:04 | A2 | | Attribute mnemonic. |
| FWIDTH | 05:07 | A3 | 001-999 or <3S> | If fixed or if variable. |
| FINTER | 08:12 | A5 | format desc or A* | If fixed or if variable. |
| ATTNAME | 13:* | A* | Attribute name | See below. |
| DIVIDER | **.* | A1 | \ | Divider. |
| FDESC | **.* | A* | Attribute description | See below. |
| DIVIDER | **.* | A1 | \ | Divider. |
| CONT_MARK | **.* | I1 | 0 | No further records. |

NOTE: * = variable integer.

Record example for a fixed record:

40PO013A13 PARENT_OSODR\Parent OSODR\0%

| | | | | | | | | |
|---|---|---|---|---|---|---|---|---|
| | 1 | 2 | 3 | 4 | 5 | 6 | 7 | 8 |
| 1 | 2 | 3 | 4 | 5 | 6 | 7 | 8 | 9 |
| 0 | 1 | 2 | 3 | 4 | 5 | 6 | 7 | 8 |
| 1 | 2 | 3 | 4 | 5 | 6 | 7 | 8 | 9 |
| 2 | 3 | 4 | 5 | 6 | 7 | 8 | 9 | 0 |
| 3 | 4 | 5 | 6 | 7 | 8 | 9 | 0 | 1 |
| 4 | 5 | 6 | 7 | 8 | 9 | 0 | 1 | 2 |
| 5 | 6 | 7 | 8 | 9 | 0 | 1 | 2 | 3 |
| 6 | 7 | 8 | 9 | 0 | 1 | 2 | 3 | 4 |
| 7 | 8 | 9 | 0 | 1 | 2 | 3 | 4 | 5 |
| 8 | 9 | 0 | 1 | 2 | 3 | 4 | 5 | 6 |
| 9 | 0 | 1 | 2 | 3 | 4 | 5 | 6 | 7 |

Template

Record example for a variable record:

40JN A* JUNCTION_NAME\Name Of Road Junction\0%

| | | | | | | | | |
|---|---|---|---|---|---|---|---|---|
| | 1 | 2 | 3 | 4 | 5 | 6 | 7 | 8 |
| 1 | 2 | 3 | 4 | 5 | 6 | 7 | 8 | 9 |
| 2 | 3 | 4 | 5 | 6 | 7 | 8 | 9 | 0 |
| 3 | 4 | 5 | 6 | 7 | 8 | 9 | 0 | 1 |
| 4 | 5 | 6 | 7 | 8 | 9 | 0 | 1 | 2 |
| 5 | 6 | 7 | 8 | 9 | 0 | 1 | 2 | 3 |
| 6 | 7 | 8 | 9 | 0 | 1 | 2 | 3 | 4 |
| 7 | 8 | 9 | 0 | 1 | 2 | 3 | 4 | 5 |
| 8 | 9 | 0 | 1 | 2 | 3 | 4 | 5 | 6 |
| 9 | 0 | 1 | 2 | 3 | 4 | 5 | 6 | 7 |

Template

Text Record [TEXTREC] 43

| Field | Position | Format | Value example | Description |
|-----------|----------|--------|---------------|--------------------------------|
| REC_DESC | 01:02 | A2 | 43 | |
| TEXT_ID | 03:08 | I6 | | Unique text record identifier. |
| NUM_SEL | 09:10 | I2 | 01 | |
| SELECT | 11:12 | A2 | 00 | |
| TEXT_CODE | 13:16 | A4 | 0000 | |
| TEXP_ID | 17:22 | I6 | | Pointer to [TEXTPOS] record. |
| NUM_ATT | 23:24 | I2 | 01 | |
| ATT_ID | 25:30 | I6 | | Pointer to [ATTREC] record. |
| CONT_MARK | 31:31 | I1 | 0 | No further records. |
| EOR | 32:32 | A1 | % | Record terminator. |

Record example:

4300000701000000000007010002670%

| 1 | 2 | 3 | 4 | 5 | 6 | 7 | 8 |
|------------|------------|------------|------------|------------|------------|------------|------------|
| 1234567890 | 1234567890 | 1234567890 | 1234567890 | 1234567890 | 1234567890 | 1234567890 | 1234567890 |

Template

Text Representation Record [TEXTREP] 45

| Field | Position | Format | Value example | Description |
|-----------|----------|--------|---------------|--|
| REC_DESC | 01:02 | A2 | 45 | |
| TEXR_ID | 03:08 | I6 | | Unique text representation record identifier – cross reference from [TEXTPOS]. |
| FONT | 09:12 | I4 | 0004 | Text font Identity. |
| TEXT_HT | 13:15 | R3,1 | | Text height in millimetres. |
| DIG_POSTN | 16:16 | I1 | | Digitising position 0–8. |
| ORIENT | 17:20 | R4,1 | | Anticlockwise from grid east. |
| CONT_MARK | 21:21 | I1 | 0 | No further records. |
| EOR | 22:22 | A1 | % | Record terminator. |

Record example:

450000070004020300000%

| | 1 | 2 | 3 | 4 | 5 | 6 | 7 | 8 |
|--|---|---|---|---|---|---|---|---|
| 12345678901234567890123456789012345678901234567890123456789012345678901234567890 | | | | | | | | |

Template

Comment Record [COMMENT] 90

| Field | Position | Format | Value example | Description |
|-------------|----------|--------|---------------|--------------------------|
| REC_DESC | 01:02 | A2 | 90 | |
| RECORD_TYPE | 03:04 | I2 | | Changed NTF record type. |
| RECORD_ID | 05:17 | A13 | | Unique ID (OSODR). |
| CHANGE_TYPE | 18:18 | A1 | D or I or U | Type of change. |
| CONT_MARK | 19:19 | I1 | 0 | No further records. |
| EOR | 20:20 | A1 | % | Record terminator. |

Record example:

902301J945LPCABAXU0%

| | 1 | 2 | 3 | 4 | 5 | 6 | 7 | 8 |
|--|---|---|---|---|---|---|---|---|
| 12345678901234567890123456789012345678901234567890123456789012345678901234567890 | | | | | | | | |

Template

| Field | Position | Format | Value example | Description |
|-----------|----------|--------|-----------------------------|---------------------|
| REC_DESC | 01:02 | A2 | 90 | |
| FREE_TEXT | 03:* | A* | NO OSCAR DATA FOR THIS TILE | |
| CONT_MARK | *.* | I1 | 0 | No further records. |
| EOR | *.* | A1 | % | Record terminator. |

NOTE: * = variable integer.

Record example:

90NO OSCAR DATA FOR THIS TILE0%

| | 1 | 2 | 3 | 4 | 5 | 6 | 7 | 8 |
|--|---|---|---|---|---|---|---|---|
| 12345678901234567890123456789012345678901234567890123456789012345678901234567890 | | | | | | | | |

Template

Volume Terminator Record [VOLTERM] 99

| Field | Position | Format | Value example | Description |
|-----------|----------|--------|---------------|---|
| _DESC | 01:02 | A2 | 99 | |
| FREE_TEXT | 03:* | A* | | See note below. |
| CONT_VOL | *+1:*+1 | I1 | 0 or 1 | No continuation volume or continuation volume follows. |
| EOR | *+2:*+2 | A1 | % | Record terminator. |

NOTES:

If there are further volume(s) to follow then the FREE_TEXT field comprises the following message:

'End Of Volume (nn). Transfer Set Continues On Volume (nn+1)'

If there are no further volumes then the FREE_TEXT field will read:

'End Of Transfer Set'

* = variable integer.

Record examples:

99End Of Volume 01 Transfer Set Continues On Volume 021%

| | | | | | | | | |
|---|---|---|---|---|---|---|---|---|
| | 1 | 2 | 3 | 4 | 5 | 6 | 7 | 8 |
| 1 | 2 | 3 | 4 | 5 | 6 | 7 | 8 | 9 |
| 0 | 1 | 2 | 3 | 4 | 5 | 6 | 7 | 8 |
| 1 | 2 | 3 | 4 | 5 | 6 | 7 | 8 | 9 |
| 2 | 3 | 4 | 5 | 6 | 7 | 8 | 9 | 0 |
| 3 | 4 | 5 | 6 | 7 | 8 | 9 | 0 | 1 |
| 4 | 5 | 6 | 7 | 8 | 9 | 0 | 1 | 2 |
| 5 | 6 | 7 | 8 | 9 | 0 | 1 | 2 | 3 |
| 6 | 7 | 8 | 9 | 0 | 1 | 2 | 3 | 4 |
| 7 | 8 | 9 | 0 | 1 | 2 | 3 | 4 | 5 |
| 8 | 9 | 0 | 1 | 2 | 3 | 4 | 5 | 6 |
| 9 | 0 | 1 | 2 | 3 | 4 | 5 | 6 | 7 |

Template

99End Of Transfer Set0%

| | | | | | | | | |
|---|---|---|---|---|---|---|---|---|
| | 1 | 2 | 3 | 4 | 5 | 6 | 7 | 8 |
| 1 | 2 | 3 | 4 | 5 | 6 | 7 | 8 | 9 |
| 0 | 1 | 2 | 3 | 4 | 5 | 6 | 7 | 8 |
| 1 | 2 | 3 | 4 | 5 | 6 | 7 | 8 | 9 |
| 2 | 3 | 4 | 5 | 6 | 7 | 8 | 9 | 0 |
| 3 | 4 | 5 | 6 | 7 | 8 | 9 | 0 | 1 |
| 4 | 5 | 6 | 7 | 8 | 9 | 0 | 1 | 2 |
| 5 | 6 | 7 | 8 | 9 | 0 | 1 | 2 | 3 |
| 6 | 7 | 8 | 9 | 0 | 1 | 2 | 3 | 4 |
| 7 | 8 | 9 | 0 | 1 | 2 | 3 | 4 | 5 |
| 8 | 9 | 0 | 1 | 2 | 3 | 4 | 5 | 6 |
| 9 | 0 | 1 | 2 | 3 | 4 | 5 | 6 | 7 |

Template

Chapter 8 DXF explained

The purpose of this chapter and [chapter 9](#) is to:

- Provide a brief description of the presentation of Meridian 2 in the DXF transfer format.
- Data Exchange Format (DXF) (conforming to AutoCAD release 12 with extended entity data). As part of this description, data structure diagrams are used to give greater explanation where necessary.
- Provide Licensed Partners with as much detail as necessary to enable Meridian 2 files in DXF to be easily understood and processed by application software.

The term data structure used in these chapters refers to the organisation and sequence of the records in the data file and **not** to the geographical topology of the data.

These chapters should be read in conjunction with [chapter 1](#), [chapter 2](#) and [chapter 3](#), which describe the content of Meridian 2.

An overview of Meridian 2 in DXF

DXF

Meridian 2 is available in DXF, conforming to AutoCAD release 12, using extended entity data to store attributes. The transfer format is that defined by the NEDO Working Party for the exchange of two-dimensional drawings in the construction industry. An overview of the data structure of a Meridian 2 file in DXF is shown below.

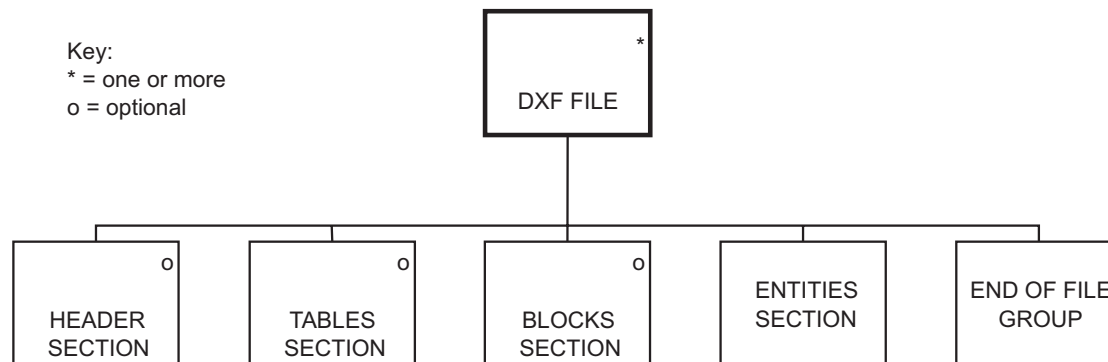

Structure of Meridian 2 in DXF

Meridian 2 has a limited link and node data structure; within this structure a feature may be a name, a point, or a line (or series of lines forming a coherent unit). Each feature is free standing; that is, its topological relationship to any other feature is **not** expressed in the data.

Features are classified by type and each type is placed in a separate DXF layer.

Line features

A feature is a subjective entity; that is, so long as the constituent lines are of the same description (layer), a feature need not fully describe a logical piece of detail.

The extent of a feature is determined by digitising conventions and does not always coincide with the topology. Each linear feature is composed of a string of XY coordinate pairs implicitly joined by straight lines.

The colour and line weights of some layers may differ when DXF is used with certain software packages.

Area features

Area features are not defined within vector link and node data. Features that might be thought of as area features are treated in the data as linear features, for example, a developed land use area boundary is treated as a polyline in layer G8056300.

Name features

Name features are treated as free standing text data. There is no explicit relationship (in the data) between a text feature and the point or line feature to which it belongs.

Ordnance Survey distinguishes between layer name types – for example, place names and station names – by placing each name type in a separate DXF layer.

Text has position, expressed as a single coordinate pair held as X and Y offsets from the map origin (south-west corner). Text that is double or treble banked is treated as two or three separate features. The text string may be considered to be contained within an envelope whose bottom left-hand corner is positioned on this coordinate pair. Text is oriented, that is, it may run from west to east across the map, or it may be plotted at some other angle measured anticlockwise from grid east.

Drawing content and format

Coordinate system

The coordinate system is National Grid (NG).

The National Grid coordinates are to a resolution of 0.01 metre. This is the resolution of the source data.

Height

No height attributes are applied to any feature.

See [chapter 3, 8 Gridded height](#).

Layer names

See the AutoCAD publication *Layer Naming Convention for CAD in the Construction Industry*, version 2, which is based upon the guidelines laid down in BS 1192: Part 5 – *Guide for structuring of computer graphic information*.

Each layer name is an eight-character string. The first four characters relate to the AUG/Autodesk system, with G (GIS) as the source of the information, and 800–899 as the part code. This product is **G805**.

The remaining four digits relate to existing Ordnance Survey digital map data in their own NTF system and are leading zero-filled.

For example:

G8055310 – Motorways

Neatline

Neatlines around the extent of the map data are added as lines in the ENTITIES section (layer name G8050572).

Grid

A grid is added as lines in the ENTITIES section (layer name G8050572). The grid is created by the translator and therefore must be specified before the translation takes place.

Grid values

Full 100 000 metre National Grid easting and northing values followed by an 'm' are added as text strings in the ENTITIES section (layer name G8050573) at each corner of the map extent, either horizontal or vertical, to read from the lower left corner of the tile.

Intermediate grid values are shown as multiples of 1 000 metres from the nearest 100 km National Grid (layer name G8050572). These are horizontal.

Meridian 2 DXF layers

| Layer name | Feature name | Linetype | Line | Entity | Colour | Block |
|------------|---|------------|------|----------|--------|----------------|
| G8053000 | Motorway | CONTINUOUS | 3 | POLYLINE | BLUE | |
| G8053001 | A road | CONTINUOUS | 1 | POLYLINE | RED | |
| G8053002 | B road | CONTINUOUS | 1 | POLYLINE | ORANGE | |
| G8053004 | Minor road | CONTINUOUS | 1 | POLYLINE | WHITE | |
| G8053500 | Road node | DOT | | INSERT | GREEN | CIRCLE (small) |
| G8053501 | Road edge node | DOT | | INSERT | GREEN | CIRCLE (small) |
| G8056140 | Railways | CONTINUOUS | 3 | POLYLINE | WHITE | |
| G8056142 | Tunnelled railway | DASHED | 1 | POLYLINE | WHITE | |
| G8056155 | Station | DOT | | INSERT | RED | CIRCLE |
| G8056730 | Railway node | DOT | | INSERT | GREEN | CIRCLE (small) |
| G8056731 | Railway edge node | DOT | | INSERT | GREEN | CIRCLE (small) |
| G8056401 | County boundary | DASHDOT | 1 | POLYLINE | GREEN | |
| G8056403 | District boundary/London borough/unitary authority | DASHED | 1 | POLYLINE | GREEN | |
| G8056405 | County/district/London borough/unitary authority boundary | DASHDOT | 1 | POLYLINE | GREEN | |
| G8056800 | Boundary neat line | CONTINUOUS | 1 | POLYLINE | GREEN | |
| G8056411 | County seed | CONTINUOUS | | INSERT | GREEN | SEEDPOINT |
| G8056415 | District seed | CONTINUOUS | | INSERT | GREEN | SEEDPOINT |
| G8056710 | Boundary node | DOT | | INSERT | GREEN | CIRCLE |
| G8056711 | Boundary edge node | DOT | | INSERT | GREEN | CIRCLE |
| G8056200 | Coastline | CONTINUOUS | 1 | POLYLINE | BLUE | |
| G8056740 | Coastline node | DOT | | INSERT | GREEN | CIRCLE |
| G8056741 | Coastline edge node | DOT | | INSERT | GREEN | CIRCLE |
| G8056300 | DLUA boundary | CONTINUOUS | 2 | POLYLINE | GREY | |
| G8056310 | DLUA seed | CONTINUOUS | | INSERT | GREY | DLUASEED |
| G8056720 | DLUA node | DOT | | INSERT | GREEN | CIRCLE |
| G8056721 | DLUA edge node | DOT | | INSERT | GREEN | CIRCLE |
| G8056801 | DLUA neat line | CONTINUOUS | 1 | POLYLINE | GREY | |
| G8056500 | Place name | STANDARD | | TEXT | WHITE | |
| G8056551 | Station name | STANDARD | | TEXT | WHITE | |

| Layer name | Feature name | Linetype | Line | Entity | Colour | Block |
|------------|------------------------------|------------|------|-----------|---------|--------------|
| G8050575 | Default | CONTINUOUS | 1 | POLYLINE | WHITE | |
| G8050571 | Footnotes | STANDARD | | INSERT | WHITE | ME_FOOTNOTES |
| G8050572 | Grid lines and values | CONTINUOUS | 1 | LINE/TEXT | WHITE | |
| G8050573 | Grid values | STANDARD | | TEXT | WHITE | |
| G8056223 | River – small | CONTINUOUS | 1 | POLYLINE | CYAN | |
| G8056224 | River – medium | CONTINUOUS | 2 | POLYLINE | CYAN | |
| G8056225 | River – large | CONTINUOUS | 3 | POLYLINE | BLUE | |
| G8056231 | Aqueduct | CONTINUOUS | 1 | POLYLINE | BLUE | |
| G8056232 | Dark link | CONTINUOUS | 1 | POLYLINE | RED | |
| G8056243 | Canal | CONTINUOUS | 1 | POLYLINE | CYAN | |
| G8056255 | Area water (lake) | CONTINUOUS | 2 | POLYLINE | BLUE | |
| G8056292 | Area water (seed) | CONTINUOUS | | INSERT | RED | SEEDPOINT |
| G8056552 | Water text | STANDARD | | TEXT | WHITE | |
| G8056770 | Water feature (node) | DOT | | INSERT | RED | CIRCLE |
| G8056771 | Area water (node) | DOT | | INSERT | RED | CIRCLE |
| G8056772 | Area water (edge node) | DOT | | INSERT | RED | CIRCLE |
| G8056773 | Water feature (edge node) | DOT | | INSERT | RED | CIRCLE |
| G8056803 | Area water (neat line) | CONTINUOUS | 2 | POLYLINE | CYAN | |
| G8056664 | Woodland boundary | CONTINUOUS | 2 | POLYLINE | MAGENTA | |
| G8056750 | Woodland boundary node | DOT | | INSERT | RED | CIRCLE |
| G8056663 | Woodland seed | CONTINUOUS | | INSERT | GREEN | SEEDPOINT |
| G8056751 | Woodland (tile edge) node | DOT | | INSERT | GREEN | CIRCLE |
| G8056802 | Woodland (tile edge) polygon | CONTINUOUS | 1 | POLYLINE | MAGENTA | |
| G8056762 | Gridded height | DOT | | INSERT | YELLOW | |

DXF footnotes

The following footnotes are added as an insert BLOCK in the ENTITIES section of the DXF data file. The positions of the footnotes are indicated in [figure 8.1](#).

NOTE 1: Top margin centrally aligned, 1 750 ground metres, Layer: G8050571
Ordnance Survey®

NOTE 2: Top margin centrally aligned, 1 500 ground metres, Layer: G8050571
Meridian 2 data

NOTE 3: Lower left margin, 500 ground metres, Layer: G8050571
Translation date dd Mmmmmmmmm CCYY

NOTE 4: Lower left margin, 500 ground metres, Layer: G8050571
Tile reference number __ __ __

NOTE 5: Lower left margin, 500 ground metres, Layer: G8050571
Reproduced from Ordnance Survey Meridian™ 2 data with the permission of The
Controller of Her Majesty's Stationery Office.
© Crown Copyright CCYY

NOTE 6: Lower right margin, 500 ground metres, Layer: G8050571
The derived scale of the product is dependent upon the source data.

NOTE 7: Lower right margin, 500 ground metres, Layer: G8050571
The representation of a road, track or path is no evidence of a right of way. The
alignment of tunnels is approximate.

NOTE 8: Lower right margin, 500 ground metres, Layer: G8050571
Date of last amendment dd Mmmmmmmmm CCYY

NOTE 9: Lower right margin, 500 ground metres, Layer:G8050571
Product specification.

Figure 8.1: Layout of footnotes

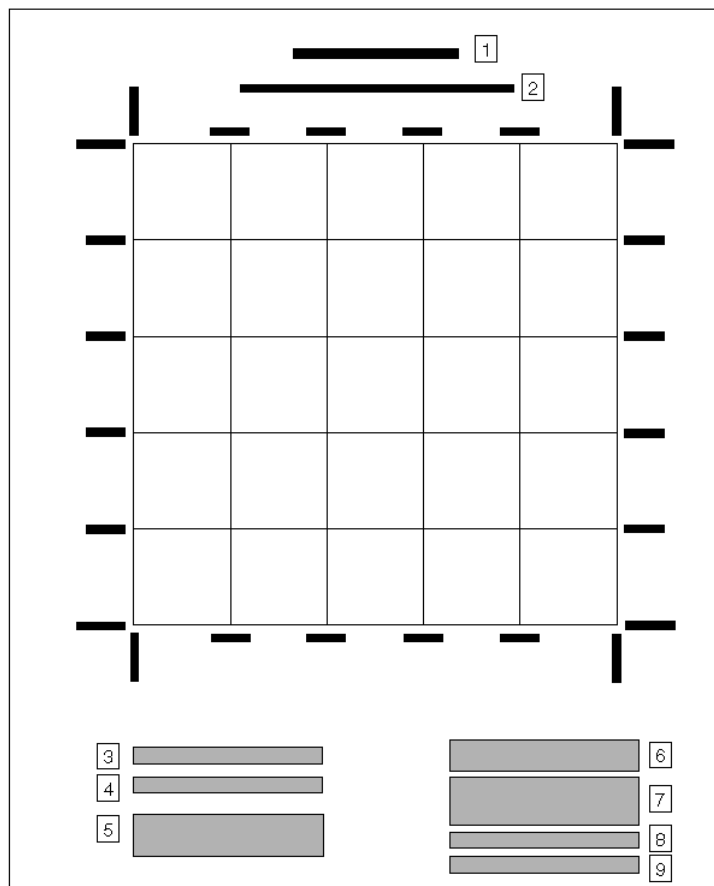

Chapter 9 DXF file structure for Meridian 2

General

The following paragraphs describe the DXF group and section structure for the transfer of Meridian 2. It is assumed that the reader of this chapter is familiar with the AutoCAD, release 12, reference manual, which is published by:

Autodesk Ltd,
1 Meadow Gate Avenue,
Farnborough Business Park,
Farnborough,
Hampshire,
GU14 6FG.
(web site: www.autodesk.co.uk)

or an equivalent document published by the reader's software supplier if a CAD package other than AutoCAD is to be used.

Meridian 2 DXF files containing Ordnance Survey data can be very large and so are supplied on CD-ROM media only.

This chapter gives a detailed breakdown of the data structure of Meridian 2 in DXF. This is a two-stage procedure that consists of:

- 1 A diagrammatic view of the data structure with a preceding outline description of that part of the data structure.
- 2 Detailed examples of the record sequence and contents of the data structure. A diagram of the record group precedes each example.

Data structure

The following diagrams ([figures 9.1–9.14](#)) represent the data structure of DXF. Where one element of a figure is the starting point for another figure, this is indicated beneath the relevant box.

For details of the specification for the DXF group, see the AutoCAD, Release 12, reference manual.

Figure 9.1: Level 1

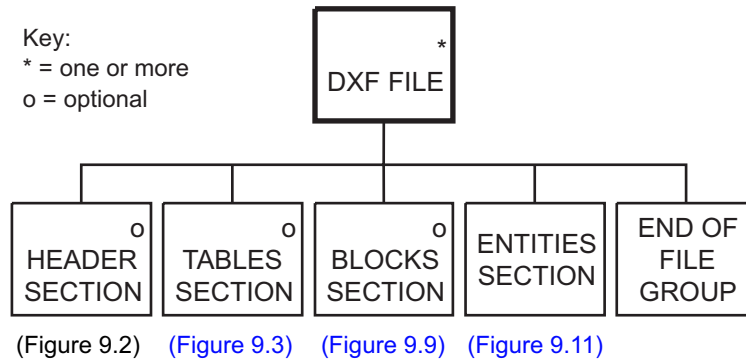

Header

The header will be constructed as follows, with only those fields being supplied.

Figure 9.2: Level 2

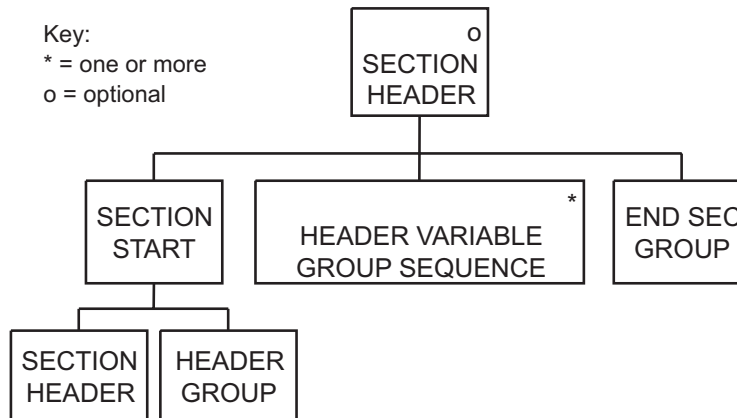

The header must be structured in the following order.

```
0
SECTION
2
HEADER
9
$ACADVER      AutoCAD drawing database version number
1
AC1009        This indicates Release 11 or 12 (not 9)
9
$EXTMIN       X and Y drawing extents lower left corner
10
nnnnnnn . nn  Minimum eastings, (National Grid coordinates)
20
nnnnnnn . nn  Minimum northings, (National Grid coordinates)
9
$EXTMAX       X and Y drawing extents, upper right corner
10
nnnnnnn . nn  Maximum eastings, (National Grid coordinates)
20
nnnnnnn . nn  Maximum northings, (National Grid coordinates)
9
$LIMMIN       X and Y drawing limits, lower left corner
10
nnnnnn . n    X drawing limit, lower left corner, (in the AutoCAD World Coordinate System (WCS))
20
nnnnnn . n    Y drawing limit, lower left corner, (in WCS)
9
$LIMMAX       X and Y drawing limits, upper right corner
10
nnnnnn . n    X drawing limit, upper right corner, (in WCS)
20
nnnnnn . n    Y drawing limit, upper right corner, (in WCS)
9
$LTSCALE      Global linetype scale
40
100.0
```

| | |
|-------------|--|
| 9 | |
| \$ATTMODE | Attribute visibility |
| 70 | |
| 1 | This sets attributes to on when the file is open |
| 9 | |
| \$FILLMODE | Fillmode on if non-zero |
| 70 | |
| 1 | |
| 9 | |
| \$TEXTSIZE | Default text height |
| 40 | |
| 1.0 | |
| 9 | |
| \$TEXTSTYLE | Current text style name |
| 7 | |
| STANDARD | |
| 9 | |
| \$CELTYPE | Entity linetype name |
| 6 | |
| BYLAYER | |
| 9 | |
| \$CECOLOR | Entity colour name |
| 62 | |
| 256 | Indicates colour ID BY LAYER |
| 9 | |
| \$LUNITS | Units format for coordinates and distances |
| 70 | |
| 2 | |
| 9 | |
| \$LUPREC | Units precision for coordinates and distances |
| 70 | |
| 1 | |
| 9 | |
| \$AUPREC | Units precision for angles |
| 70 | |
| 1 | |
| 9 | |
| \$ANGBASE | Angle zero direction |



```

50
0.0
9
$ANGDIR      Angle rotation
70
0            1 = clockwise angles, 0 = anti-clockwise angles
9
$PDMODE      Point display mode
70
1
9
$PDSIZE      Point display size
40
0.0
9
$PLINEGEN    Sets the linetype pattern generation around the vertices of a 2-dimensional Polyline
70
1
0
ENDSEC      End of Section

```

Tables

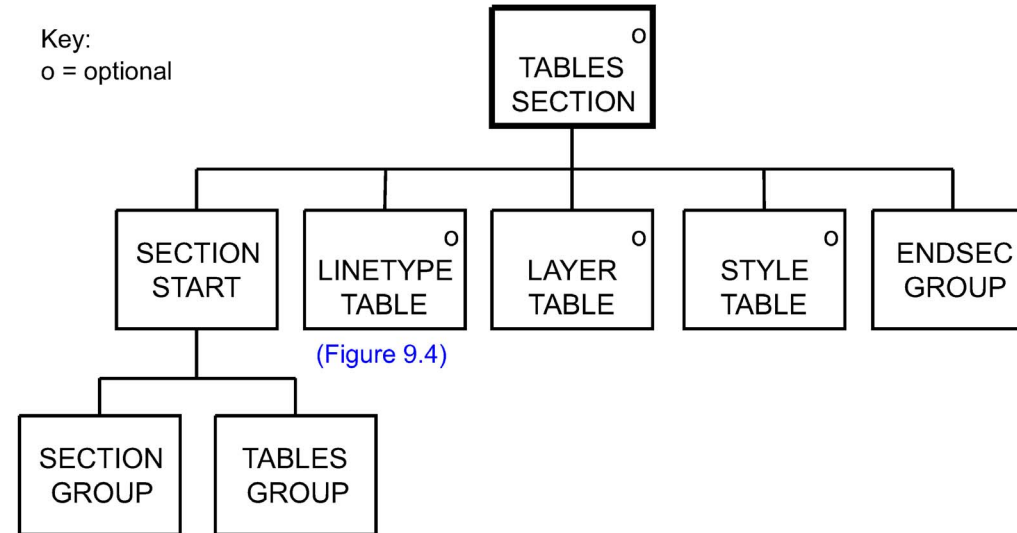
Figure 9.3: Level 2



The Tables Section will follow the Header Section and will contain three tables:

- Linetype Table.
- Layer Table.
- Style Table.

Figure 9.4: Linetype Table Level 3

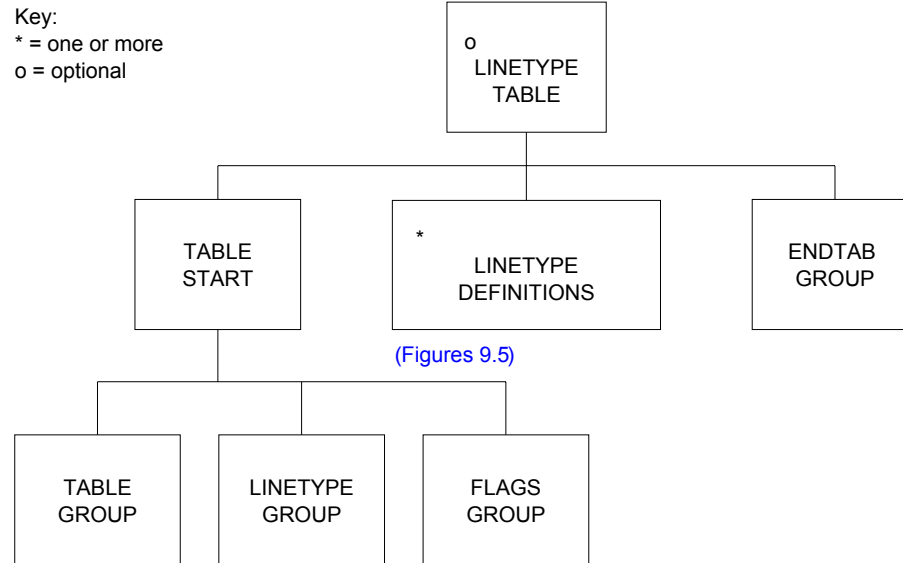

The Linetype Table will contain definitions for the following line types:

- solid line (CONTINUOUS)
- dashed line (DASHED)
- dashdot line (DASHDOT)
- dotted line (DOT)

Figure 9.5: Level 4

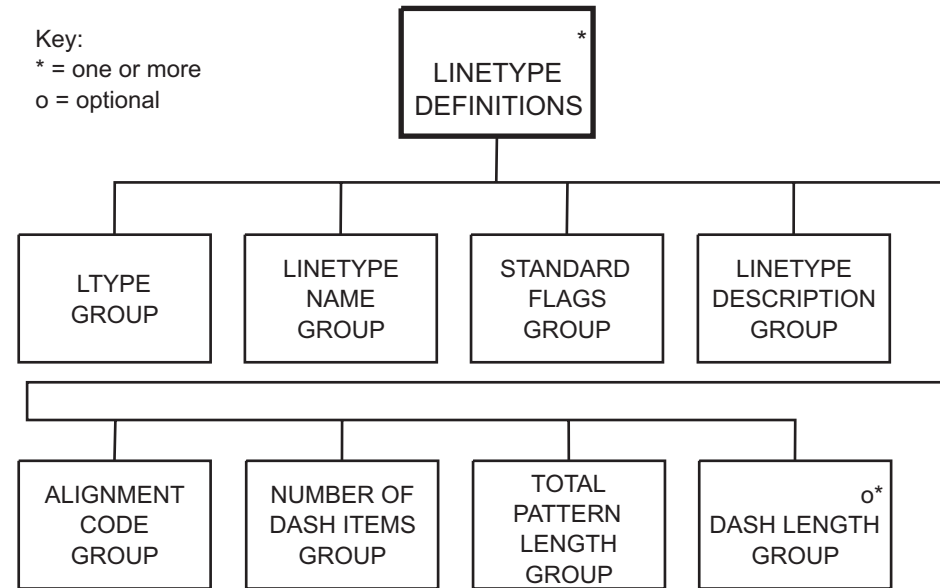

Thus:

```

0
TABLE
2
LTYPE
70
5
0
LTYPE

2
CONTINUOUS
70
  
```



```
40
1.0
49
0.5
49
-0.25
49
0.0
49
-0.25
0
LTYPE
2
DOT
70
64
3
.....
72
65

73
2
40
0.25
49
0.0
49
-0.25

0
ENDTAB
```

Figure 9.6: Level 3

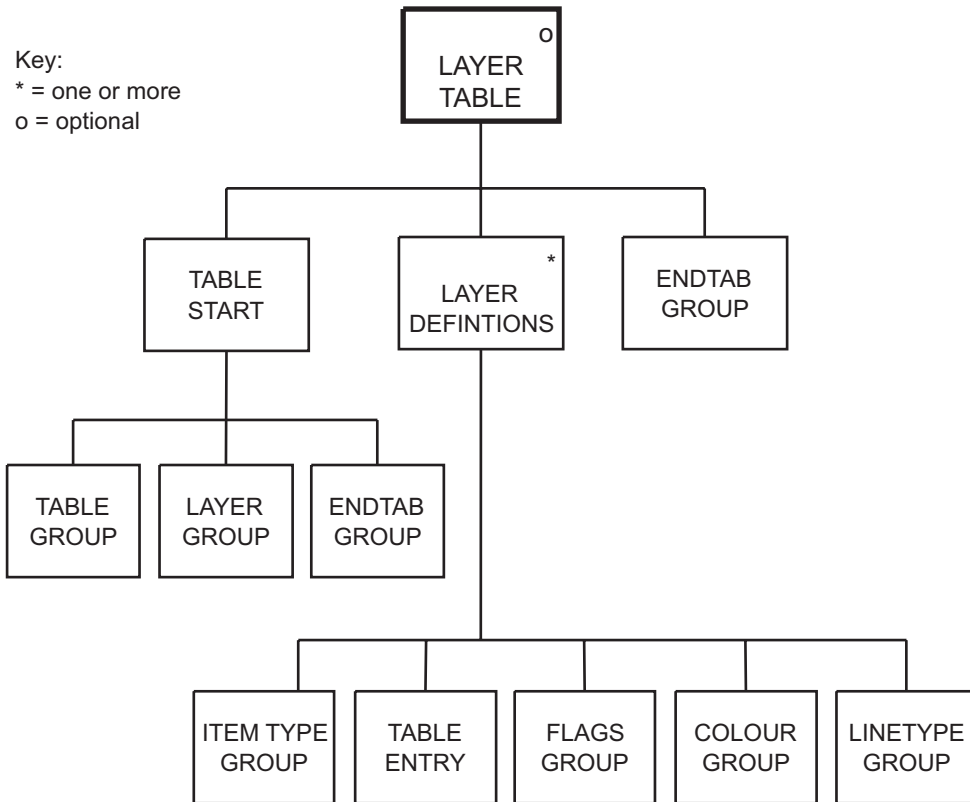

Details of the Layer Table can be seen in [Meridian 2 DXF layers](#).

Figure 9.7: Style Table level 3

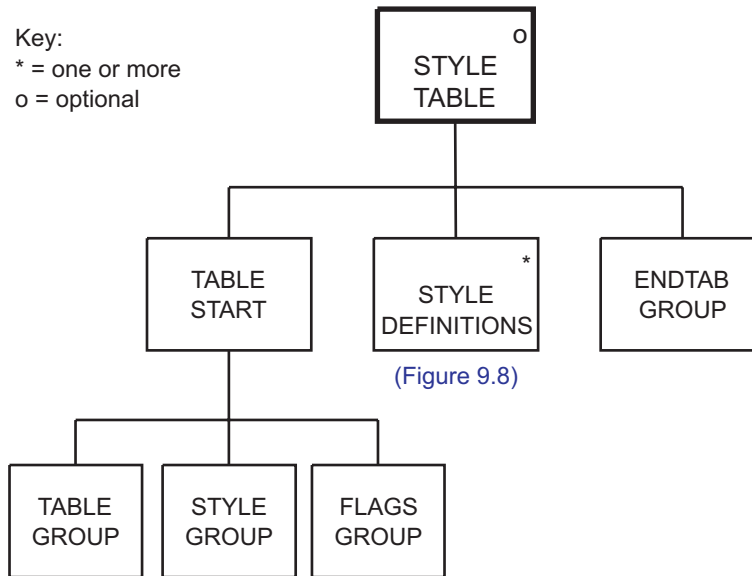

The Style Table will contain the text file load instructions for:

- SIMPLEX.SHX
- MONOTEXT.SHX

Figure 9.8: Level 4

Key:

* = one or more

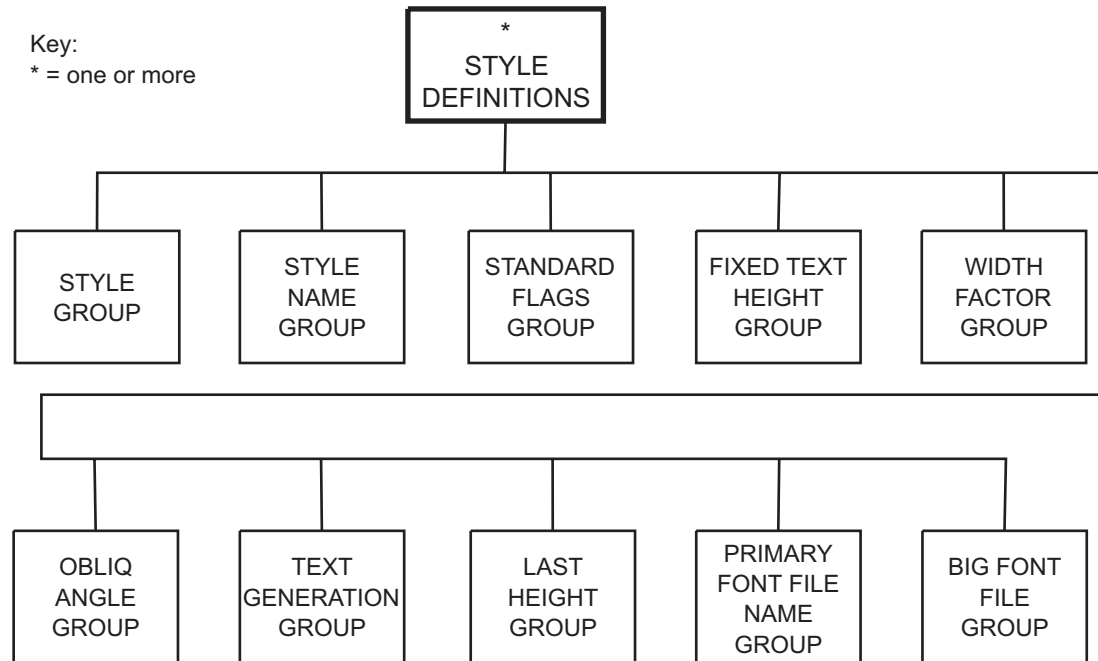

Blocks

Figure 9.9: Level 2

Key:

* = one or more

o = optional

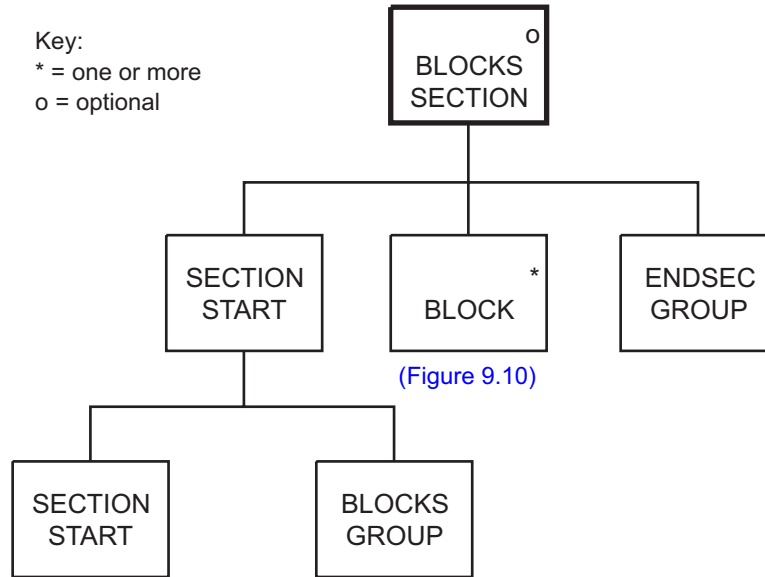
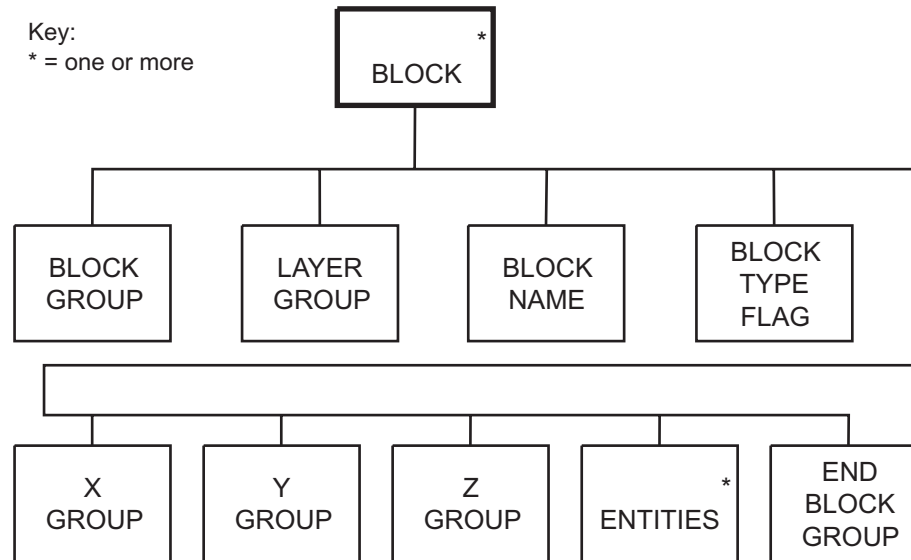

Figure 9.10: Level 3

Key:

* = one or more



Entities Section

The Entities Section will contain DXF entities for:

- Ordnance Survey map footnotes data (INSERT entities);
- Grid and neatline (TEXT and LINE entities); and
- Ordnance Survey features (TEXT, POLYLINE and INSERT entities)

Extended entity data will be used to store attributes.

The structure of each different entity is as follows:

a INSERT entities – these consist of:

- INSERT entity type group (Attribute number 0).
- Layer name group (8).
- Block name group (2).
- X coordinate group (10).
- Y coordinate group (20).
- X scale factor (41) [optional].
- Y scale factor (42) [optional].
- Orientation group (50) [optional if 0].

b LINE entities – these consist of:

- LINE entity type group (0).
- Layer name group (8).
- Start X coordinate group (10).
- Start Y coordinate group (20).
- End X coordinate group (11).
- End Y coordinate group (21).

c POLYLINE entities – these consist of:

- POLYLINE entity type group (0).
- Layer name group (8).
- Vertices follow flag group (66).
- Polyline flags group (70) [optional].
- A number of VERTEX entities [shown on the next page].
- SEQEND group (0).

d VERTEX entities – these consist of:

- VERTEX entity type group (0).
- Layer name group (8).
- X coordinate group (10).
- Y coordinate group (20).
- Z coordinate group (30).

e TEXT entities – these consist of:

- TEXT entity type group (0).
- Layer name group (8).
- X coordinate group (10).
- Y coordinate group (20).
- Text height group (40).
- Text string group (1).
- Justify type group (72) [optional if 0].
- Justify type group (73) [optional if 0].
- Orientation group (50) [optional if 0].
- Text style group (7) [optional].
- Align X group (11) [only present if Justify type group is present and has a value of 2].
- Align Y group (21) [only present if Justify type group is present and has a value of 2].

f EXTENDED entities – these consist of:

- Application name (1001).
- Control string (1002).
- String (1000) [one or more].
- Control string (1002).

Figure 9.11: Level 2

Key:
* = one or more
o = optional

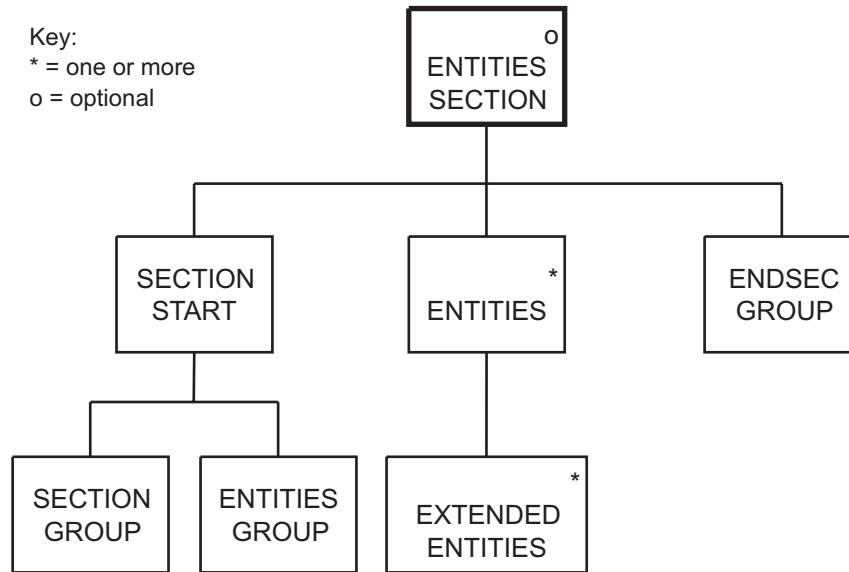

Figure 9.12: Level 3

Key:

* = one or more

o = optional

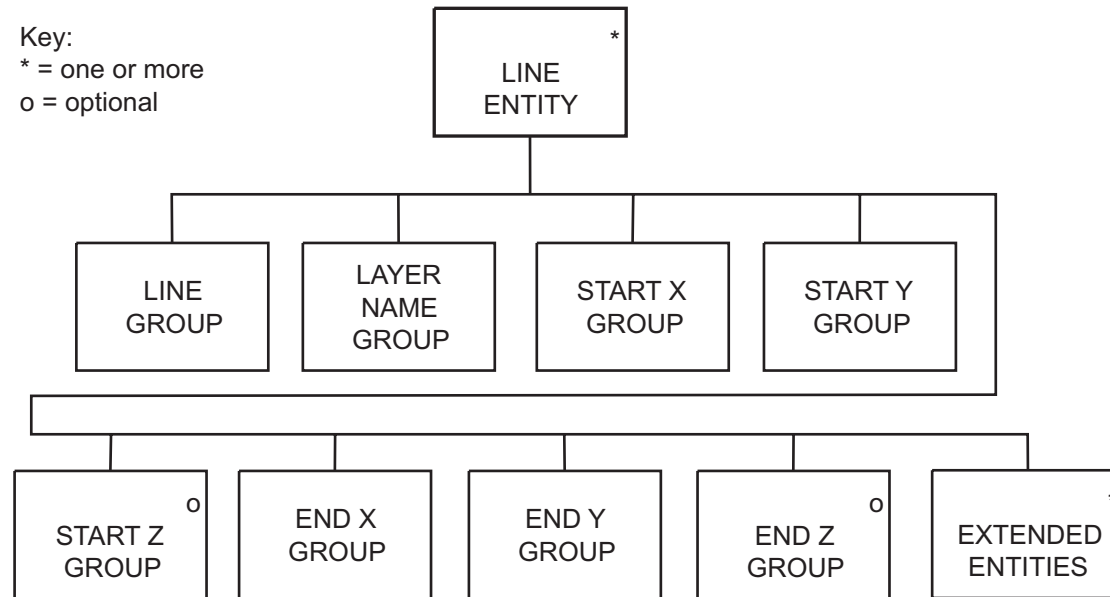

Figure 9.13: Level 3

Key:
* = one or more
o = optional

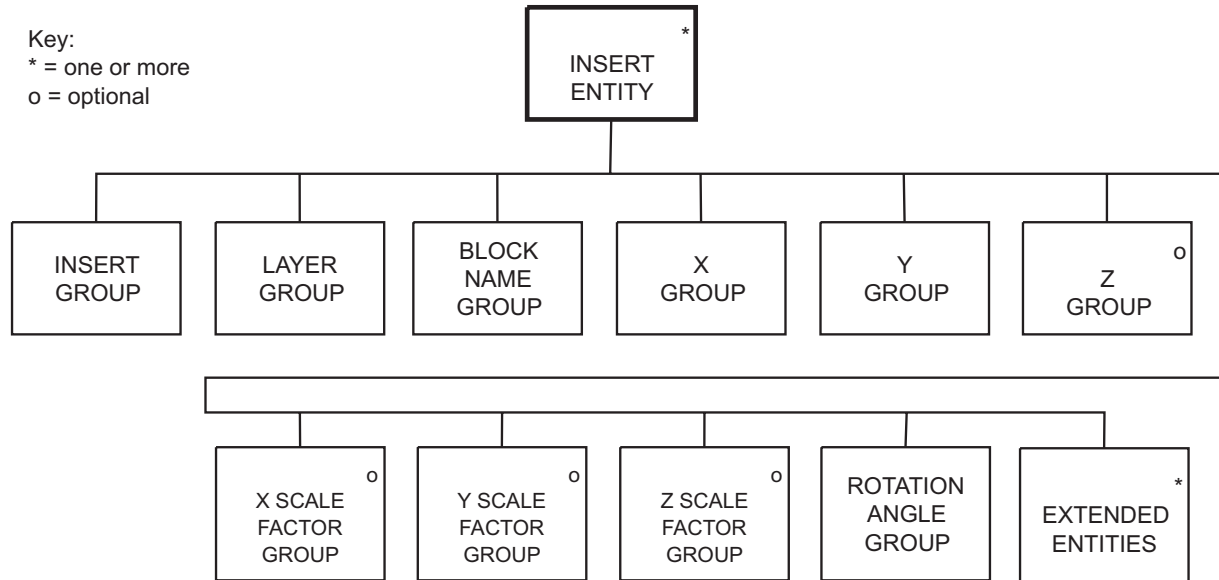

Figure 9.14: Level 3

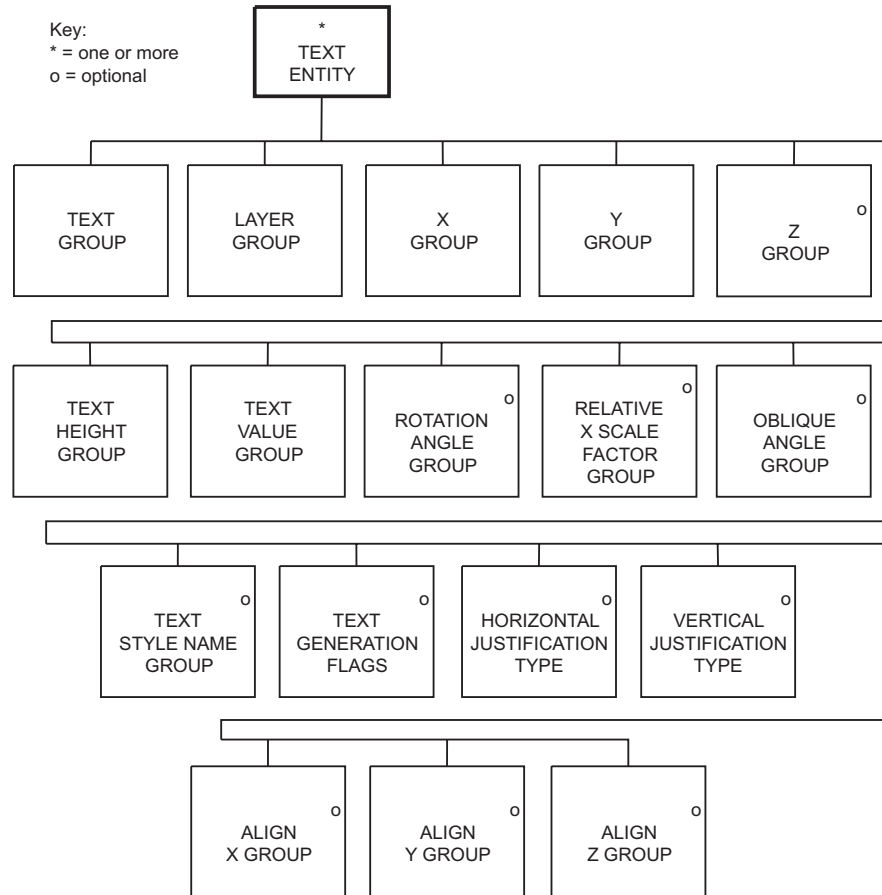
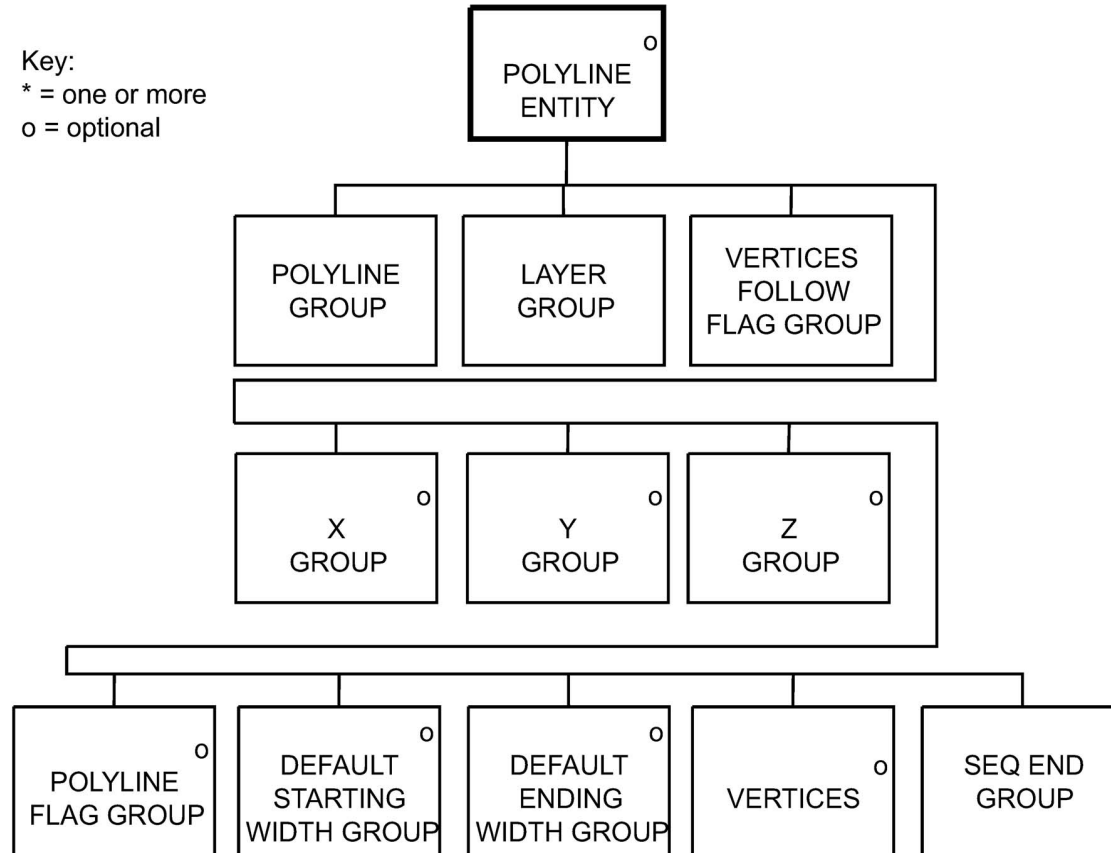

Figure 9.15: Level 3

Key:
* = one or more
o = optional



(Figure 9.16)

Figure 9.16: Vertex entity (level 4)

Key:
* = one or more
o = optional

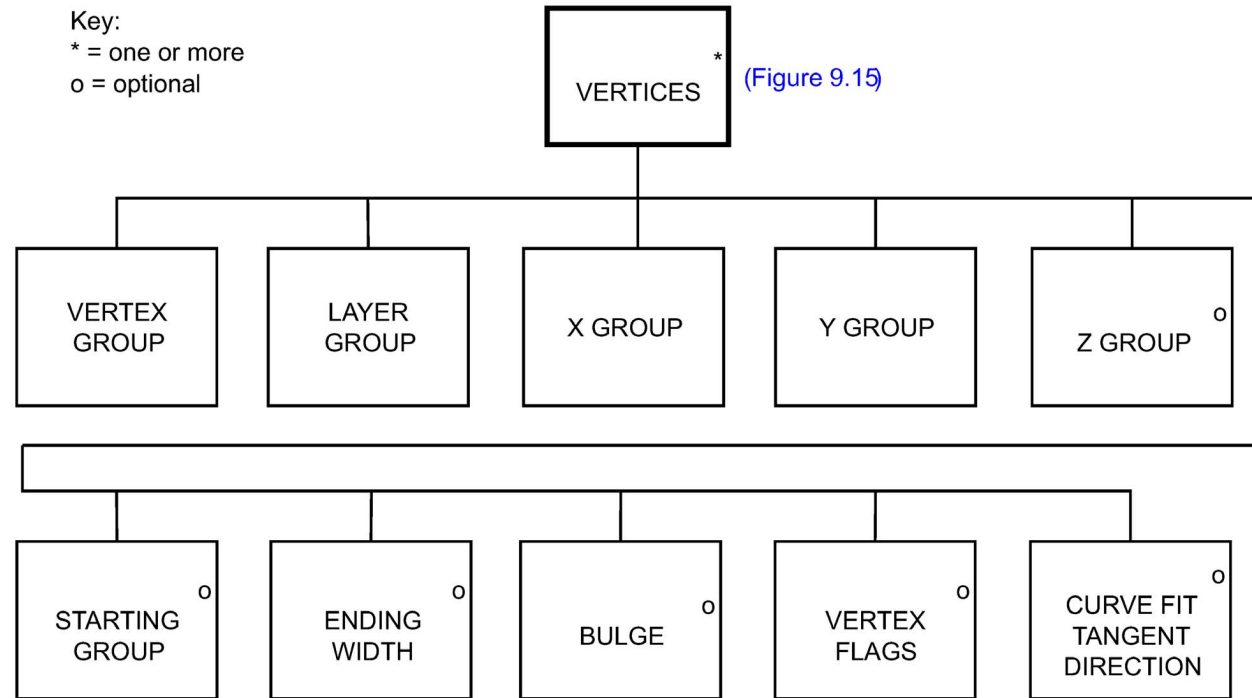

End of File Group

This group will end with DXF EOF (End Of File) group.

Chapter 10 An overview of Meridian 2 in Mid/Mif

Meridian 2 is available in Mid/Mif

The transfer format is as defined by the MapInfo Professional User's Guide: Mif Export – MapInfo Interchange Format (MIF) is an ASCII file format that can fully describe a MapInfo database. Both graphic and tabular data are exported into MIF files. The graphic data is in a file with a '.mif' extension, and the tabular data is in a file with a '.mid' extension.

MapInfo Interchange Format files can be translated into other formats with other programs.

An overview of the data structure of a Meridian 2 file in Mid/Mif is shown below.

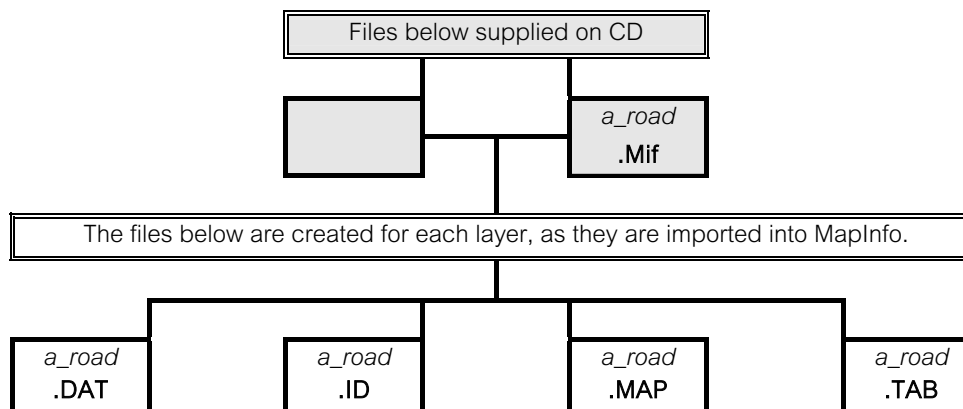

Once this is done, it's ready for use (the above example is for the A road layer).

Structure of Meridian 2 in MapInfo

Meridian 2 has a limited link and node data structure: within this structure a feature may be a name, a point or a line (or series of lines forming a coherent unit). Each feature is free standing; that is its topological relationship to any other feature is not expressed in the data. Features are classified by type and each type is placed in a separate TAB layer.

NOTE: Road change information only consists of tabular data, that is, it will not have any geographic (map) data.

Line features

A feature is a subjective entity; that is, so long as the constituent lines are the same description (layer), a feature need not fully describe a logical piece of detail.

The extent of a feature is determined by digitising conventions and does not always coincide with the topology. Each linear feature is composed of a string of XY coordinate pairs implicitly joined by straight lines. The colour and line weights for the layers are defined by the Parameter file shown in [appendix B](#).

Area features

Area Features are Polygons with attributes added.

Names features

Names features are treated as free standing text data. There is no explicit relationship (in the data) between a text feature and the point or line feature to which it belongs. Ordnance Survey distinguishes between layer name types – for example, place names and station names – by placing each name type in a separate Layer. Text has position, expressed as a single coordinate pair held as X and Y offsets from the map origin (south-west corner). If there are any double or treble banked names they will be treated as two or three separate features. Anchor points at the bottom left hand corner and digitising positions define the text string content. Text is oriented, that is, it may run from west to east across the map, or it may be plotted at some angle measured anticlockwise from grid east.

Drawing content and format

Coordinate system

The coordinate system is National Grid (NG).

The National Grid coordinates are to a resolution of 0.1 metre. This is the resolution of the source data.

Height

Height information is produced in the form of digital terrain model (DTM) style data. Gridded height information is averaged from the 50 m resolution Land-Form PANORAMA dataset to a resolution of 200 m and rounded down to the nearest 1 m value. See [chapter 3](#).

Layer names

MapInfo supports long filenames. This allows you to use up to 260 characters when naming your file. In addition, any one name within your directory path can be up to 255 characters. You can insert spaces in the filename and long filenames can have more than one "." in them. When using more than one ".", you must remember to type in the file extension in order to save the file correctly. For example you can name a table as follows: \\spam\for.lunch.today.and.every day.dbf

Layer names were created and set when the original NTF data was translated (number of layers = 22), The Meridian Import Parameters in the translator highlights a feature code and allocates it to a layer, The logic behind which layer the feature code was allocated to was down to relationship of features.

Neatline

No neatline.

Grid

No grid.

Grid values

No grid values.

Important information

Certain feature codes that are used and defined in NTF, are not required or used in MapInfo. Some examples of this are: 3501 – Road Edge Node, 6411 – County Seed, 6710 – Boundary Node, unspecified.

Other feature codes that are not used: 6415, 6711, 6800, 6741, 6310, 6720, 6721, 6801, 6731, 6730, 6292, 6770, 6771, 6772, 6773, 6803, 6663, 6802, 6750, 6751 and 6701.

See [appendix B](#) for more detail of feature codes.

Chapter 11 An overview of Meridian 2 in ESRI® shapefile

ESRI shapefiles are a simple, non-topological format for storing the geometric location and attribute information of geographic features. A shapefile is one of the spatial data formats that you can work with in ArcView GIS.

The shapefile format defines the geometry and attributes of geographically-referenced features in as many as five files with specific file extensions that should be stored in the same project workspace. They are:

.shp – the file that stores the feature geometry.

.shx – the file that stores the index of the feature geometry.

.dbf – the dBASE file that stores the attribute information of features. When a shapefile is added as a theme to a view, this file is displayed as a feature table.

.sbn and **.sbx** – the files that store the spatial index of the features. These two files may not exist until you perform theme on theme selection, spatial join, or create an index on a theme's shape field. If you have write access to the source data directory, the index files will be persistent and remain after your ArcView session is complete. If you do not have write access to the source data directory, they will be removed when you close the project or exit ArcView.

.ain and **.aih** – the files that store the attribute index of the active fields in a table or a theme's attribute table. These two files may not exist until you perform Link on the tables. If you have write access to the source data directory, the index files will be persistent and remain after your ArcView session is complete. If you do not have write access to the source data directory, they will be removed when you close the project or exit ArcView.

The native shapefile format used by ArcView GIS does not support text, thus any text files converted into shapefile format will become a coverage of points. In order to display cartographic text in ArcView (including orientated text), it is necessary to translate the data into ArcInfo® Interchange Format (E00), and then use the Import 71 utility (supplied with ArcView) to convert the text data into an Arc coverage.

ArcView will display shapefiles (and Arc coverages) with a random point/line/region/text style each time they are opened. ArcView legend files can therefore be created to enable the data to be displayed with the same symbology whenever it is displayed. When using a legend file it is possible to display the features in a theme based on one of the theme's attributes (this essentially creates a thematic or unique values map). In a unique values map a different colour is used to symbolise each value in an attribute.

In the case of Meridian 2 the cartographic text theme uses a unique values legend to distinguish place names, station names, and water text. All other themes use single symbol legends, that is, all features in the theme will be displayed using the same symbology.

In order for the legend files to work, they must have the same filename as the one to which they correspond, for example, 'motorways.shp' must have a legend file called 'motorways.avl'.

Structure as MID/MIF, see [chapter 10](#).

Drawing content and format as MID/MIF also see [chapter 10](#).

NOTE: Road change information only consists of tabular data, that is, it will not have any geographic (map) data.

Important information

Certain feature codes that are used and defined in NTF are not required or used in ESRI shapefiles. Some examples of this are: 3501 – Road Edge Node, 6411 – County Seed, 6710 – Boundary Node, unspecified.

Other feature codes that are not used: 6415, 6711, 6800, 6741, 6300, 6310, 6720, 6721, 6801, 6731, 6730, 6255, 6292, 6770, 6771, 6772, 6773, 6803, 6664, 6663, 6802, 6750, 6751 and 6701.

Symbology table

| Feature code | Description | Symbol | Legend |
|--------------|------------------------------|--------|---|
| FC3000 | Motorway | Single | MOTORWAY_L |
| FC3001 | A Road | Single | AROAD_L |
| FC3002 | B Road | Single | BROAD_L |
| FC3004 | Minor Road | Single | MINORROAD_L |
| FC3500 | Road Node, Unspecified | Single | ROADNODE_P / JUNCTION_P / ROUNDBABOUT_P / SETTLEMENT_P |
| FC3501 | Road Edge Node, Unspecified | Single | |
| FC6140 | Railway | Single | RAILWAYLINE_L |
| FC6142 | Railway (Tunnelled) | Single | RAILWAYLINE_L |
| FC6155 | Station, Point | Single | RAILWAYSTN_P |
| FC6200 | Coast | Single | COASTLINE_L |
| FC6223 | Water Feature (River Small) | Single | RIVER_L |
| FC6224 | Water Feature (River Medium) | Single | RIVER_L |
| FC6225 | Water Feature (River Large) | Single | RIVER_L |
| FC6230 | Water Feature (Hidden) | Single | RIVER_L |
| FC6231 | Water Feature (Aqueduct) | Single | RIVER_L |
| FC6232 | Water Feature (Dark Link) | Single | RIVER_L |
| FC6243 | Water Feature (Canal) | Single | RIVER_L |
| FC6255 | Area Water (Lake) | Single | LAKES_A |
| FC6292 | Area Water (Seed) | Single | |
| FC6300 | DLUA Boundary | Single | DLUA_A |
| FC6310 | DLUA Seed-Point | Single | |
| FC6401 | County Boundary | Single | ADMINLINE_L / COUNTY_A |
| FC6403 | District Boundary | Single | ADMINLINE_L / DISTRICT_A |
| FC6405 | County/District Boundary | Single | ADMINLINE_L |
| FC6411 | County Seed-Point | Single | |
| FC6415 | District Seed-Point | Single | |

| Feature code | Description | Symbol | Legend |
|---------------------|------------------------------|---------------|---------------|
| FC6500 | Names | Unique | CARTOTEXT_T |
| FC6551 | Station Name | Unique | CARTOTEXT_T |
| FC6552 | Water Text | Unique | CARTOTEXT_T |
| FC6663 | Woodland Seed | Single | |
| FC6664 | Woodland Boundary | Single | WOODLAND_A |
| FC6710 | Boundary Node, Unspecified | Single | |
| FC6711 | Boundary Edge Node | Single | |
| FC6720 | DLUA Node, Unspecified | Single | |
| FC6721 | DLUA Edge Node, Unspecified | Single | |
| FC6730 | Railway Node | Single | |
| FC6731 | Railway Edge Node | Single | |
| FC6740 | Coast Node, Unspecified | Single | |
| FC6741 | Coast Edge Node, Unspecified | Single | |
| FC6750 | Woodland Node | Single | |
| FC6751 | Woodland Edge Node | Single | |
| FC6762 | Height Point Feature | Single | HEIGHT_P |
| FC6770 | Water Feature (Node) | Single | |
| FC6771 | Area Water (Node) | Single | |
| FC6772 | Area Water (Edge Node) | Single | |
| FC6773 | Water Feature (Edge Node) | Single | |
| FC6800 | Admin Area (Neat Line) | Single | |
| FC6801 | DLUA (Neat Line) | Single | |
| FC6802 | Woodland (Neat Line) | Single | |
| FC6803 | Area Water (Neat Line) | Single | |

Appendix A Glossary

accuracy

The closeness of the results of observations, computations or estimates to the true values or the values accepted as being true. Accuracy relates to the exactness of the result, and is the exactness of the operation by which the result is obtained.

administrative area

A blanket term used by Ordnance Survey to refer to all public administrative areas, specifically local government management and electoral areas.

American Standard Code for Information Interchange (ASCII)

A seven-bit code for encoding a standard character set.

area

A spatial extent defined by circumscribing lines that form a closed perimeter that does not intersect itself.

area seed

A point within an area that can be used to carry the attributes of the whole area, for example, ownership, address and use type.

attribute

An attribute is a property of an entity, usually used to refer to a non-spatial qualification of a spatially referenced entity. For example, a descriptive code indicating what an entity represents or how it should be portrayed.

attribute class

A specific group of attributes, for example, those describing measure, serviceability, structure or composition.

attribute code

An alphanumeric identifier for an attribute type.

attribute value

A specific quality or quantity assigned to an attribute.

basic scale

The scale at which the survey is maintained. For Ordnance Survey mapping, three scales (1:1250, 1:2500 and 1:10 000) are used. Any area is only maintained at one basic scale.

block

Data on magnetic media may be recorded in blocks of characters for more efficient movement within or between computer systems. The length of the block will vary according to the medium and the data transfer format used.

boundary

A boundary is the limit of a predefined and established area whose limit is determined by one or more [lines](#), for example, county area boundary and developed land use area boundary.

byte

A unit of computer storage of binary data usually comprising 8 bits, equivalent to a character. Hence [megabyte](#) (Mb) and [gigabyte](#) (Gb).

CAD

Computer-aided design.

cartography

The organisation and communication of geographically related information in either graphic or digital form. It can include all stages from data acquisition to presentation and use.

character

A distinctive mark; an inscribed letter; one of a set of writing symbols.

character string

A one-dimensional array of characters held either in memory or in another storage medium.

coding

Allocation of a feature code to a feature being created from constituent construction data – points and/or segments; with optional linking to an existing feature of the same feature code.

compact disc-read only memory (CD-ROM)

A data storage medium. A 12-cm disc similar to an audio CD. Ordnance Survey uses the writable CD, a WORM (write once read many) device. The digital bits are encoded into a vegetable dye and, once written, cannot be erased by overwriting with subsequent data. A laser reads the disc.

continuation mark

A logical record may contain more data than can be held in a single physical record. The physical record contains a continuation mark – the penultimate character of the record in NTF – to indicate whether more data is to be found in a continuation record.

continuation record

A specific NTF term. A continuation record is used where space does not allow one logical record to be contained wholly within one physical record.

coordinate pair

A coordinate pair is an easting and a northing.

coordinates

Pairs of numbers expressing horizontal distances along original axis. Alternatively, that triplets of numbers measuring horizontal and vertical distances. Row and column numbers of pixels from raw imagery are not considered coordinates for the purpose of the standard.

copyright

Copyright is a legal property right that enables the creator of an original work to protect it from unauthorised use. Through the *Copyright, Designs and Patents Act 1988*, Crown copyright continues to subsist in all Ordnance Survey products until the end of the period of 50 years from the end of the year in which they were published, and in the case of data from the end of the year in which it was extracted from the Ordnance Survey database. Crown copyright is vested in The Controller of Her Majesty's Stationery Office, who has delegated powers to the Director General, Ordnance Survey for the administration of copyright in publications and data, including the determination of terms and conditions under which permission for their reproduction is given.

currency

An expression of the up-to-dateness of data.

data

A representation of facts, concepts or instructions in a formalised manner suitable for communication, interpretation or processing.

data capture

The encoding of data. In the context of digital mapping, this includes map digitising, direct recording by electronic survey instruments and the encoding of text and attributes by whatever means.

data format

A specification that defines the order in which data is stored or a description of the way data is held in a file or record.

data model

An abstraction of the real world that incorporates only those properties thought to be relevant to the application or applications at hand. The data model would normally define specific groups of **entities** and their **attributes** and the relationship between these entities. A data model is independent of a computer system and its associated data structures. A map is one example of an analogue data model.

database

An organised, integrated collection of data stored so as to be capable of use in relevant applications, with the data being accessed by different logical paths. Theoretically it is application-independent, but in reality it is rarely so.

dataset

An Ordnance Survey term for a named collection of logically related features arranged in a prescribed manner. For example, all water features. A dataset has more internal structure than a layer and is related to another dataset only by position.

DDS

Digital Data Storage.

density

A measure of the number of units of data held on a stated length of storage surface.

detached part

A term applying to a part of a local government or parliamentary area that is completely surrounded by other local government or parliamentary areas, and is not connected to the parent area by direct access on the ground.

digital

Data that is expressed as numbers (digits) in computer-readable form is said to be digital.

digital map

Any map sold by Ordnance Survey or its agents in any form, that is, on computer-readable media or as hard copy on paper and/or film or microfilm – produced mainly, or wholly, using computerised means.

digital map data

The digital data required to represent a map. The data includes not only map detail but also feature header data, map header data and management data.

digitising

The process of converting analogue maps and other sources to a computer-readable form. This may be point digitising, where points are only recorded when a button is pressed on a cursor, or stream digitising where points are recorded automatically at preset intervals of either distance or time as the cursor is traced along a map feature.

distinctive name

A text feature consisting of text string(s) that form(s) a proper name.

DXF (Data Exchange Format)

A proprietary data format, devised by Autodesk, by which digital drawings may be transferred between users of CAD (computer-aided design) systems. DXF has become an industry standard data format and is used for the transfer of some Ordnance Survey data products.

eastings

See [rectangular coordinates](#).

edgematch

The process of ensuring that data along the adjacent edges of map sheets, or some other unit of storage, matches in both positional and attributes terms.

entity

Something about which data is stored in a databank or database. For example, building or tree. The data may consist of relationships, attributes, positional and shape information and so on. Often synonymous with feature.

Extended Binary Coded Decimal Interchange Code (EBCDIC)

An eight-bit character encoding scheme.

Extent of the realm (EOR)

The external bounding lines of Land-Line[®] data is EOR. *The Territorial Waters Jurisdiction Act 1878* and the *Territorial Waters Order in Council 1964* confirm that EOR of Great Britain as used by Ordnance Survey is properly shown to the limit of mean low water (mean low water springs in Scotland) for the time being (except where extended by Parliament).

feature

An item of detail within a map that can be either a point or symbol, a line or text.

feature classification record

A specific named NTF record that lists the feature codes in use in the current database.

feature code (FC)

An alphanumeric attribute code used in digital map data to describe each feature in terms of the object surveyed, its representation on the map, or both.

feature serial number (FSN)

A number used as a feature identifier usually allocated on a sequential basis. For example, the order in which features are digitised.

field

A specific part of a record containing a unit of data, such as the date of digitising. The unit of data may be a data element or a data item. In NTF a field is a subdivision of a physical record. Every field has a name and a predefined interpretation.

file

An organised collection of related records. The records on a file may be related by a specific purpose, format or data source – the records may or may not be arranged in sequence. A file may consist of records, fields, words, bytes, characters or bits.

font

The style of text character used by a printer or plotter.

format

The specified arrangement of data. For example, the layout of a printed document, the arrangement of the parts of a computer instruction, the arrangement of data in a [record](#).

geographical information system (GIS)

A system for capturing, storing, checking, integrating, analysing and displaying data that is spatially referenced to the Earth. This is normally considered to involve a spatially referenced computer [database](#) and appropriate applications software.

geometric structure

The ground is modelled in the data as a series of lines and points.

gigabyte (Gb)

1 073 741 824 bytes; a measure of data storage capacity.

grid

The planimetric frame of reference. For example, the National Grid.

hard copy

A print or plot of output data on paper or some other tangible medium.

junction

A connection between two or more links at a common node.

kilobyte (Kb)

1 024 bytes; a measure of data storage capacity.

layer

A subset of digital map data, selected on a basis other than position. For example, one layer might consist of all features relating to roads and another to railways.

line

A series of connected coordinated points forming a simple feature with homogeneous attribution.

line feature

The spatial abstraction of an object in one dimension. Lines may intersect with other lines. They are defined as a series of two or more coordinates and may be curved or straight. Curved lines consist of a series of very short straight line segments. Lines may be concurrent with other lines under certain conditions. As an object abstraction a line has no width.

line segment

A vector connecting two coordinated points.

linear feature

Map feature in the form of a line, for example, road centrelines, that may or may not represent a real-world feature.

link

Links are the representation of line features. They are made up of one or more consecutive, non-intersecting, link segments with common attributes, between two terminating nodes. Links have no connection with other links except at the start or end via common (shared) terminating nodes (points). All links contain their terminating coordinates. Links may form the boundaries of polygons and may be shared between polygons. See also [line](#).

link and node data

A form of vector data in which linear features are represented as links. Links are terminated where they intersect other links. These intersection points, and link ends, may carry nodes whose feature records express the geometric relationships between links.

link and node structure

A data structure in which links and nodes are stored with cross referencing.

map

The representation on a flat surface of all or part of the earth's surface, intended to be communicated for a purpose or purposes, transforming relevant geographic data into an end-product that is visual, digital or tactile.

map generalisation

A reduction in map detail, so that the information remains clear and uncluttered when map scale is reduced. May also involve resampling to larger spacing and/or a reduction in the number of points in a line.

map header

Data at the start of the digital map file describing that data. It may contain information on the source and history of the geometric data within the map and the coordinate system in use as well as holding information essential to the management of Ordnance Survey's digital mapping system.

map scale

The ratio between the extent of a feature on the map and its extent on the ground, normally expressed as a representative fraction, for example, 1:1250 or 1:50 000.

megabyte (Mb)

1 048 576 bytes; a measure of data storage capacity.

Mid/Mif definition

MID is a MapInfo database and Mif is a MapInfo Interchange, which is an ASCII file format and is used for export. Tabular data is held in a file with a '.mid' extension and graphic data is held in a file with a '.mif' extension. Mif files can be translated into other formats and used with other programmes.

name or text feature

The proper name or label of an object (real-world) or feature (object abstraction) consisting of one or more text strings. A name position is defined by a coordinate pair.

National Grid

A unique referencing system that can be applied to all Ordnance Survey maps of Great Britain (GB) at all scales. It is based on 100 km squares covering the whole of GB based on a Transverse Mercator projection. It is used by Ordnance Survey on all post-war mapping to provide an unambiguous spatial reference in GB for any place or entity whatever the map scale.

National Transfer Format (NTF)

A format designed in 1988 specifically for the transfer of spatial information; it is published as *British Standard BS 7567* and is administered by the British Standards Institution. It is now the standard transfer format for Ordnance Survey digital map data.

node

An object representation of a point that either does not form any part of a link (isolated node or polygon seed point); or is the representation of a point at the start or end of a link (terminating node). The position of a node is defined by a single coordinate pair – which is repeated within all links logically connected at that node and/or containing it. A node is only deleted if the link containing it as a terminating node is deleted.

northings

See [rectangular coordinates](#).

orientation

Orientation of a point or a text feature is measured in degrees anticlockwise from grid east.

origin

The zero point in a system of [rectangular coordinates](#).

packing

Spaces used as fillers to complete a record or field.

pecked line

A line drawn as a series of dashes.

physical record

A physical record may be fixed length containing 80 characters or variable length containing **up to** 80 characters.

point

A zero-dimensional spatial abstraction of an object represented as a coordinate pair.

point and line data

A form of vector data designed for map production in which all map features are designated as points, lines or text. Point and line data does not carry the topological relationships between features.

point feature

A zero-dimensional spatial abstraction of an object with its position defined by a coordinate tuple. Points are represented by nodes, which may be isolated or part of a link (terminating). Points may also be represented by symbols that may have attributes such as rotation and size.

polygon

Polygons are a representation of areas. A polygon is defined as a closed line or perimeter completely enclosing a contiguous space and made up of one or more links. At least one node occurs on the perimeter of a polygon where the bounding link completes the enclosure of the area. There may be many nodes connecting the bounding links of a polygon. Links may be shared between polygons. Polygons may wholly contain other polygons, or be contained within other polygons. Each may contain a single isolated node (seed point) that identifies the polygon.

polygon boundary

The link or links that enclose a polygon, projected into the horizontal plane.

polygon point

See [seed point](#).

positional accuracy

The degree to which the coordinates define a point's true position in the world, directly related to the spheroid/projection on which the coordinate system is based.

precision

The exactness with which a value is expressed, whether the value be right or wrong.

record

A set of related data fields grouped for processing.

recording format

The logical and/or physical levels of the protocol governing the laying down of data on the physical transfer medium.

rectangular coordinates

Also known as X-Y coordinates and as [eastings](#) and [northings](#). These are two-dimensional coordinates that measure the position of any point relative to an arbitrary origin on a plane surface, for example, a map projection, a digitising table or a VDU screen.

resolution

A measure of the ability to detect quantities. High resolution implies a high degree of discrimination but has no implication as to [accuracy](#). For example, in a collection of data in which the [coordinates](#) are rounded to the nearest metre, resolution will be 1 m but the accuracy may be ± 5 m or worse.

section

In NTF terminology, a subdivision of a database. In Ordnance Survey terms this equates to a single map sheet, that is, a digital map file or a tile.

seed

A seed is a digitised point within an area, usually a defined polygon, for example, a lake or woodland, but not always, for example, a geographical seed such as the South Downs.

seed point

A coordinated point (an isolated node) within an area (usually a defined polygon) to which alphanumeric information may be attached as an attribute, for example, a name or a feature code. Also known as a polygon seed, area seed, or representative point.

segment

A chord defined by two consecutive [coordinates](#) in a line string.

shapefile or '.shp'

SRI shapefiles are a simple, non-topological format for storing the geometric location and attribute information of geographic features. A shapefile is one of the spatial data formats that you can work with in ArcView GIS.

source scale

The scale of the source information from which the map was digitised, that is, the scale of survey for a basic-scale map, or the scale of the source map for a derived map.

spatial data

Data that includes a reference to a two- or three-dimensional position in space as one of its attributes. It is used as a synonym for geometric data.

structured data

Data within which collections of features (of any type) form objects. Topographically structured data also contains topological information defining the relationships between features and objects.

terminator

A character, character string, field, or record used to signal the end of a record, section, volume or database.

text coordinates

Each text feature has a *start-of-text* coordinate that is digitised.

text feature

A free-standing text string in the digital data describing a feature, or particular instance of a feature, for example, Factory or Acacia Avenue.

text height

The height at which a text string is intended to be plotted out at the nominal map scale. This information is included in the feature header of the text feature.

text position

See text coordinates. Also known as *original digitising position*.

tile

Broadly synonymous with digital map file, it implies evenly sized map sheet units.

topographic database

A database holding data relating to physical features and boundaries on the Earth's surface.

topography

Topography is the study of the physical features of the Earth. A topographic map's principal purpose is to portray and identify the features of the Earth.

topology

The study of the properties of a geometric figure that are not dependent on position, such as connectivity and relationships between lines, nodes and polygons.

transfer format

The format used to transfer data between computer systems. In general usage this can refer not only to the organisation of data but also to the associated information, such as attribute codes, which are required in order to successfully complete the transfer.

transfer medium

The physical medium on which digital data is transferred from one computer system to another. For example, CD-ROM.

transfer set

A specific NTF term for the data, together with its supporting information, which the customer receives.

update

The process of adding to and revising existing digital map data to take account of change.

vector

A straight line joining two data points.

vector data

Positional data in the form of coordinates of the ends of line segments, points, text positions and so on.

volume

A physical unit of the transfer medium, that is, a single disc.

Appendix B Meridian 2: (MapInfo) Mid/Mif layers

This section contains a list of all the valid features used with Meridian 2. The list contains a description of each feature code, its feature name, its feature type and list of the style information required to create an output. Each feature layer then contains other information as attributes.

Important information

Certain feature codes that are used and defined in NTF, are not required or used in MapInfo. Some examples of this are: 3501 – Road Edge Node, 6411 – County Seed, 6710 – Boundary Node, unspecified. Other feature codes that are not used: 6415, 6711, 6800, 6741, 6310, 6720, 6721, 6801, 6731, 6730, 6292, 6770, 6771, 6772, 6773, 6803, 6663, 6802, 6750, 6751 and 6701.

| File | Description | Data type | Feature code |
|------|-------------|-----------|--|
| 1 | motorway | Line | 3000, 6001 |
| 2 | a_road | Line | 3001, 6041 |
| 3 | b_road | Line | 3002, 6061 |
| 4 | minor_rd | Line | 3004, 6080 |
| 5 | junction | Node | 3500, 6700 |
| 6 | rndabout | Node | 3500 |
| 7 | settlemt | Node | 3500 |
| 8 | roadnode | Node | 3500, 6700 |
| 9 | rail_ln | General | 6140, 6142 |
| 10 | station | General | 6155 |
| 11 | county | General | 6401 |
| 12 | district | General | 6403 |
| 13 | coast_ln | General | 6200 |
| 14 | admin_ln | General | 6401, 6403, 6405 |
| 15 | dlua | General | 6300 |
| 16 | text | General | 6551, 6500, 6405, 6552 |
| 17 | river | General | 6223, 6224, 6225, 6230, 6231, 6232, 6243 |
| 18 | lake | General | 6255 |
| 19 | woodland | General | 6664 |
| 20 | height | Height | 6762 |

Roads – post 1 January 2000–current; FC 3000 full spec of OSCAR Route-Manager, tiles as 10 km by 10 km

| Feature code | Feature names | Type | Style |
|--------------|--|-------------|--|
| 3000 | Motorway | Line | Pen (3,2,5278719) |
| 3001 | A Road | Line | Pen (2,2,16711680) |
| 3002 | B Road | Line | Pen (2,2,16750640) |
| 3004 | Minor Road | Line | Pen (1,2,8421504) |
| 3500 | Road Standard Node (Motorway junction) | Font Symbol | Symbol (63,7381247,9,"MapInfo Weather",16,0) |
| 3500 | Road Standard Node (Roundabout) | Symbol | Symbol (34,8421504,6) |
| 3500 | Road Standard Node (Settlement) | Symbol | Symbol (32,16776960,5) |
| 3500 | Road Standard Node (Link information) | Font Symbol | Symbol (50,8421504,2,"MapInfo Symbols",0,0) |
| 3501 | Road Edge Node | Font Symbol | Symbol (51,8421504,5,"MapInfo Symbols",0,0) |

Administrative areas and Coastline

| Feature code | Feature names | Type | Style |
|--------------|-------------------------------|---------|---|
| 6401 | County polygon | Polygon | Pen (1,2,16776960), Brush (2,13697000,16777215) |
| 6401 | County boundary line | Line | Pen (1,23,32896) |
| 6403 | District polygon | Polygon | Pen (1,2,16777215), Brush (2,13696976,16777215) |
| 6403 | District boundary line | Line | Pen (1,24,0) |
| 6405 | County/District boundary line | Line | Pen (1,23,0) |
| 6411 | County seed | Symbol | Symbol (34,0,9) |
| 6415 | District seed | Symbol | Symbol (34,0,9) |
| 6710 | Boundary node unspecified | Symbol | Symbol (34,0,9) |
| 6711 | Boundary edge node | Symbol | Symbol (34,0,9) |
| 6800 | Admin area (neat line) | Line | Pen (1,2,0) |
| 6200 | Coast | Line | Pen (1,2,4227327) |
| 6740 | Coast node, unspecified | Symbol | Symbol (34,4227327,9) |
| 6741 | Coast edge node, unspecified | Symbol | Symbol (34,4227327,9) |

Developed land use area (DLUA)

| Feature code | Feature names | Type | Style |
|--------------|-----------------------------|---------|---|
| 6300 | DLUA polygon | Polygon | Pen (1,1,16768208), Brush (2,16762032,16777215) |
| 6300 | DLUA boundary line | Line | Pen (1,2,16768208) |
| 6310 | DLUA seed-point | Symbol | Symbol (34,16768208,9) |
| 6720 | DLUA node, unspecified | Symbol | Symbol (34,16768208,9) |
| 6721 | DLUA edge node, unspecified | Symbol | Symbol (34,16768208,9) |
| 6801 | DLUA (neat line) | Line | Pen (1,2,16768208) |

Railways

| Feature code | Feature names | Type | Style |
|--------------|---------------------|--------|------------------------|
| 6140 | Railway | Line | Pen (2,2,0) |
| 6142 | Railway (tunnelled) | Line | Pen (2,3,0) |
| 6155 | Station, point | Symbol | Symbol (34,16711680,9) |
| 6731 | Railway edge node | Symbol | Symbol (34,16711680,9) |
| 6730 | Railway node | Symbol | Symbol (34,16711680,9) |

Cartographic names

| Feature code | Feature names | Type | Style |
|--------------|---------------|------|---|
| 6551 | Station name | Text | Font ("Times New Roman",0,7,8388608,-1) |
| 6500 | Names | Text | |

Hydrology

| Feature code | Feature names | Type | Style |
|--------------|---------------------------------|---------|---|
| 6223 | Water feature (river small) | Line | Pen (1,2,4243711) |
| 6224 | Water feature (river medium) | Line | Pen (2,2,4243711) |
| 6225 | Water feature (river large) | Line | Pen (3,2,4243711) |
| 6230 | Water feature (hidden) | Line | Pen (1,3,4243711) |
| 6231 | Water feature (aqueduct) | Line | Pen (1,193,4243711) |
| 6232 | Water feature (dark link) | Line | Pen (1,3,32896) |
| 6243 | Water feature (canal) | Line | Pen (1,2,65535) |
| 6255 | Area water (lake polygon) | Polygon | Pen (1,2,65535),Brush (2,11593215,16777215) |
| 6255 | Area water (lake boundary line) | Line | Pen (1,2,255) |
| 6292 | Area water (seed) | Symbol | Symbol (49,4227327,12) |
| 6770 | Water feature (node) | Symbol | Symbol (49,4227327,12) |
| 6771 | Area water (node) | Symbol | Symbol (49,4227327,12) |
| 6772 | Area water (edge node) | Symbol | Symbol (49,4227327,12) |
| 6773 | Water feature (edge node) | Symbol | Symbol (49,4227327,12) |
| 6803 | Area water (neat line) | Line | Pen (1,2,255) |
| 6552 | Water Text | Text | Font ("Times New Roman",2,8,255,-1) |

Woodlands

| Feature code | Feature names | Type | Style |
|--------------|------------------------|---------|--|
| 6664 | Woodland polygon | Polygon | Pen (1,1,32896), Brush (2,11599792,16777215) |
| 6664 | Woodland boundary line | Line | Pen (1,2,32896) |
| 6663 | Woodland seed | Symbol | Symbol (49,0,12) |
| 6802 | Woodland (neat line) | Line | Pen (1,2,32896) |
| 6750 | Woodland node | Symbol | Symbol (49,0,12) |
| 6751 | Woodland edge node | Symbol | Symbol (49,0,12) |

Height

| Feature code | Feature names | Type | Style |
|--------------|----------------------|-------------|--|
| 6762 | Height Point feature | Font Symbol | Symbol (35,12632256,2,"MapInfo Symbols",0,0) |

Roads – pre 1 January 2000; FC 6000 stripped OSCAR Route-Manager, tiles as 20 km by 20 km

| Feature code | Feature names | Type | Style |
|--------------|--|-------------|---|
| 6001 | Motorway [Meridian 1] | Line | Pen (2,2,5278719) |
| 6041 | A Road [Meridian 1] | Line | Pen (2,2,16711680) |
| 6061 | B Road [Meridian 1] | Line | Pen (2,2,16744448) |
| 6080 | Minor Road [Meridian 1] | Line | Pen (1,2,8421504) |
| 6700 | Road Standard Node (Junc) [Meridian 1] | Font Symbol | Symbol (35,8421504,5,"MapInfo Symbols",0,0) |
| 6700 | Road Standard Node (Link inf) [Meridian 1] | Font Symbol | Symbol (50,8421504,5,"MapInfo Symbols",0,0) |
| 6701 | Road Edge Node [Meridian 1] | Symbol | Symbol (50,8421504,5) |

Appendix C Product and service performance report form

Ordnance Survey welcomes feedback about Meridian 2 from its customers.

If you would like to share your thoughts with us, please print a copy and when completed post it to the address below.

Your name: Phone:.....

Organisation: Fax:

Address: Email:

..... Quotation or order reference:

.....

Postcode:

Please record your comments or feedback in the space below. We will acknowledge receipt of your form within 3 working days and provide you with a full reply or a status report within 21 working days.

If you are posting this form, please send it to:

Meridian 2 Product Manager, Room C427, Ordnance Survey, Romsey Road, SOUTHAMPTON, SO16 4GU.

Fax: 023 8079 2615